

MUTOH

XPJ-1682UR

Operation Manual

Operations and Maintenance Methods

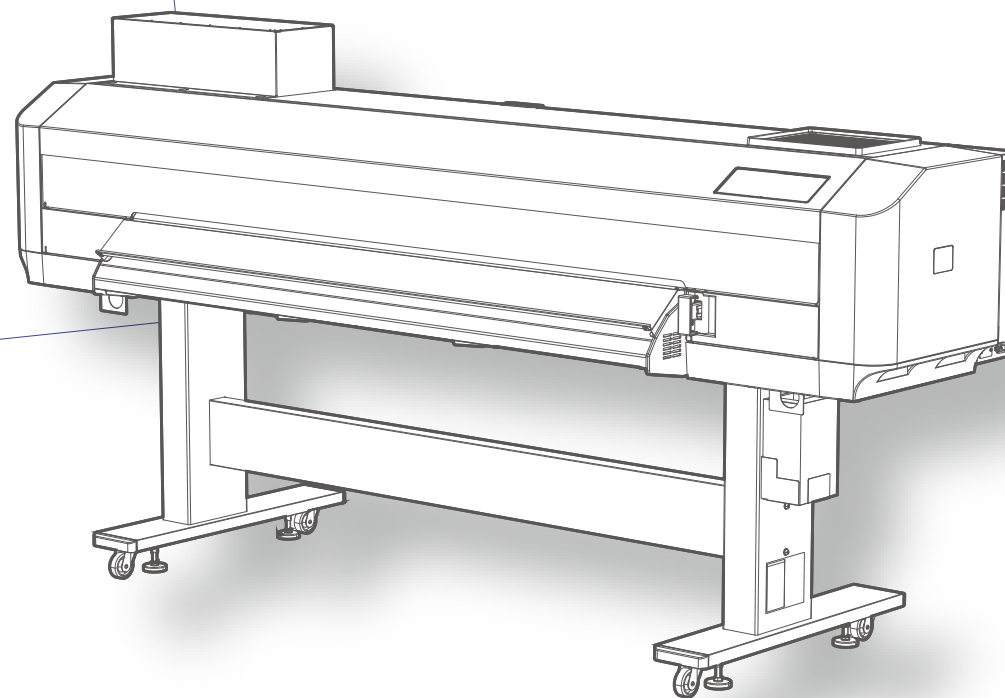

Important Notice

For Users in Europe

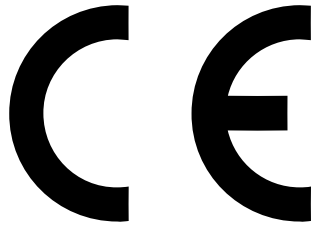

The CE marking is a mandatory European marking for certain product groups to indicate conformity with the essential health and safety requirements set out in European Directives.

By affixing the CE marking, the manufacturer, his authorized

representative, or the person placing the product on the market or putting it into service ensures that the item meets all the essential requirements of all applicable EU directives and that the applicable conformity assessment procedures have been applied.

For Users in the United States

This equipment has been tested and found to comply with the limits for a Class A digital device, pursuant to Part 15 of the FCC Rules. These limits are designed to provide reasonable protection against harmful interference when the equipment is operated in a commercial environment. This equipment generates, uses, and can radiate radio frequency energy and, if not installed and used in accordance with the instruction manual, may cause harmful interference to radio communications.

Operation of this equipment in a residential area is likely to cause harmful interference in which case the user will be required to correct the interference at his own expense.

This system (including the housing and safety device) is a Class 2 laser product.

Laser specifications of this system (including the housing)

Wavelength: 655 nm, maximum output: 1 mW or less, pulse duration: 3 μ s

- Complies with IEC 60825-1 Edition 3.0 (2014-05-15). Complies with FDA performance standards for laser products except for deviations pursuant to Laser notice No.56 dated May 8, 2019.

CAUTION

Use of controls or adjustments or performance of procedures other than those specified herein may result in radiation exposure.

Microsoft® and Windows® are either registered trademarks or trademarks of Microsoft Corporation in the United States and/or other countries.

VerteLith™ is trademark of MUTOH INDUSTRIES LTD.

Company names and product names that appear in this Guide are registered trademarks or trademarks of the respective companies.

-
- Unauthorized copying or duplication of the whole or part of the contents of this Guide is prohibited.
 - Every care has been taken in writing the contents of this Guide, but please contact MUTOH or the dealer you purchased the product from if you find any unclear, erroneous or otherwise unsatisfactory content in the Guide.
 - Please be aware that MUTOH will not be liable in any way for failures or accidents that result from handling or operating the printer according to any procedures other than those set forth in this Guide.

For Safe Use 7

Safety Precautions 8

- Symbols 8
- Electrical shock hazard / Fire hazard 9
- Installation 11
- Handling 12
- Ink and waste fluid 14
- Warning labels 16
- Instruction Labels 20

Before Use 22

Printer main components / Functions 23

- Front view 23
- Rear view 25
- Printer control panel 27
- Direct keys 29
- Ink level indicator on the printer control panel 31
- Applying the ink color labels 32

Connecting to a computer 33

System configurations of this product 35

Launching/ Opening/ Exiting MSM 36

- Launching MSM 36
- Displaying MSM 36
- Displaying remote panel 37
- Exiting MSM 37

Installing VerteLith 38

Printing area 39

Supported media 40

- Media size 40
- Media handling cautions 41
- Precaution on storing media after use 41

Precautions 42

- Do not power off the printer 42
- Please use this printer regularly 42
- Please conduct maintenance regularly 42
- Some parts need to be replaced periodically 43
- Use the product in a place that meets "Environmental Requirements" 43

Basic Operations 44

Printing workflow 45

Powering ON / OFF 46

- Turning the power ON 46

Table of Contents

Turning the power OFF	47	Menus you can access while printing	102
Loading a roll media into the printer.....	49	Sleep Mode.....	103
Loading a roll media into the printer	49	Sleep mode flow.....	103
Nozzle check and cleaning	61	To wake up from sleep mode.....	104
Run a nozzle check	61		
Perform a head cleaning	65		
Calibrating your printer	67		
Print head calibration ("Adjust Head")	68		
Print quality calibration ("Adjust Print")	72		
Media feed adjustment	78		
Start printing	84		
Print an image.....	84		
Pause / Resume / Cancel a print job	89		
Advanced settings	90		
Printhead Height	91		
Changing holddown pressure using media feed lever.....	93		
Canceling or reducing pressure rollers individually.....	94		
Operating from the printer control panel	97		
Feeding media	97		
Pausing / Resuming printing	98		
Canceling printing.....	99		
Cutting media	100		
Displaying the time until the next time ink agitation is required	101		
		Various Settings	105
		Key operation.....	106
		Print settings menu	108
		Select Nozzle	119
		Automatic nozzle checking (when optional drop sensor is installed) ...	121
		Test Print menu	123
		Maintenance menu	126
		Printer Status menu	128
		System Information menu.....	130
		Roll Length Manage menu	131
		Scan.....	133
		Media Adjustment menu.....	135
		Ink Agitation menu	137
		Print Stop setting	137
		Sleep Mode menu	141

Maintenance 142

About Maintenance143

Wearing protective equipment144

 How to wear the supplied gloves..... 144

Agitating ink.....145

 When using ink cartridges 154

 When using ink bags with high-capacity ink pack adapters..... 156

Checking ink level and replacing cartridge.....158

 Check the ink level..... 158

 When an ink cartridge (ink bag) is nearing replacement..... 159

 Replacing with a new ink..... 160

Emptying waste ink tank167

 Procedure 168

Daily maintenance at the end of work171

 Step 1. Preparations for maintenance..... 172

 Step 2. Putting the printer into Sleep mode..... 173

 Step 3. Perform a daily maintenance..... 174

 Step 4. Ending the daily maintenance 183

Printer maintenance185

 Head cleaning 185

 Soak Cleaning 186

 Cleaning each part of the printer 189

 Cleaning the color sensor 191

 Cleaning inside the printer..... 193

Replacing consumable parts195

 Replacement flow 196

 Replacing the flushing box pad 197

 Replacing the cleaning wiper 201

 Replacing Cutter..... 204

 Replace the filter of UV-LED lamp..... 207

 Replace the emitting window glass of the UV-LED lamp..... 209

 Replacing and cleaning the exhaust fan filter 212

When not using the printer for a long period of time ..

216

Moving or transporting the printer218

 Moving the printer..... 218

 Transporting the printer 221

 Initial ink charging after flushing ink out of the printer 222

When problems occur 227

Messages and Error Messages228

 Status messages..... 228

 Error message display and remedies..... 232

Table of Contents

Smartchip recovery 237

Error requiring restart 238

Troubleshooting239

Installation and initial setup-related trouble 239

Boot-up trouble 241

Media-related trouble..... 242

Printing-related trouble 244

The media is jammed 249

Appendix **252**

Specifications.....253

Optional accessories / Consumable supplies256

Revision history.....257

For Safe Use



Safety Precautions

Symbols



In this document, the following symbols are used for the instructions that must be followed to avoid risk of harm to human health or damage to the property.

Please read and understand the meaning of each symbol and ensure the proper use of the printer.



■ Warnings and cautions

 Warning	Failure to follow the instructions could result in serious injury or death.
 Caution	Failure to follow the instructions could result in minor injury or damage to the product.

■ Actions that must be avoided or instructions that must be followed

	Indicates an action that must be avoided. A black symbol in the sign indicates the prohibited action.
	Indicates an important instruction that must be followed. A symbol in the sign indicates the instruction must be followed.

■ Other symbols

 Important !	Provides information that require special attention or should be followed.
 Note	Provides supplemental or reference information.
	Indicates the link to the reference section.







Note

For the name of each part marked with warning or caution symbols, see "Before Use" on the XPJ-1682UR operation manual.

Safety Precautions

Electrical shock hazard / Fire hazard

 **Warning**

	<p>Do not install this product in a location with high humidity and dust. This could result in an electrical shock or fire.</p>		<p>Make sure to use a designated power socket.</p>
	<p>Do not use a damaged power cord. This could result in an electrical shock or fire.</p>		<p>Plug the power cord into the wall outlet. Do not use power strips. This could result in fire.</p>
	<p>Do not connect or disconnect the power plug with wet hands. This could result in an electrical shock.</p>		<p>Plug the power cords into the wall outlet that has the earth connection and make sure to connect the earth. If the earth is not connected, an electrical shock or fire may occur.</p>
	<p>Do not connect an earth wire to the following places:</p> <ul style="list-style-type: none"> • Gas pipe It has potential risks of fire and explosion. • Earth wire of telephone cables or lighting rods Large current may flow when the lightning strikes. • Water pipe or faucet It may not work properly if a plastic pipe is connected to the pipe. 		<p>Make sure to connect an earth wire to the earth connection that meets the following requirements:</p> <ul style="list-style-type: none"> • Earth terminal of power socket. • An earth wire with a copper plate which is buried at 650 mm or more in the ground.
			<p>Keep ink away from fire or heat source and store in a cool, dark place in order to avoid risk of fire.</p>
	<p>Be sure to use the designated power cords. Failure to do so could result in an electrical shock or fire. For the designated power cord, please contact your local MUTOH dealer.</p> <ul style="list-style-type: none"> • The power cord should have the protective ground terminal and make sure to plug in securely. • Use the power cords which meet the safety standard, voltage and plug shape of the country to use this product. 		
	<p>Do not insert or drop metal or flammable objects into the printer through openings such as vent. This could result in an electrical shock or fire.</p>		<p>Do not block the vent on the product with cloth or other materials. If covered, the inside the product gets hot, resulting in fire.</p>

For Safe Use

Before Use

Basic Operations







Various Settings

Maintenance

When problems occur

Appendix





Safety Precautions

	Never open the covers securing with screws. This could result in an electrical shock or damage to the printer.		Make sure to follow the instructions on this guide to connect the power cord or cables. Failure to do so could result in fire.
	Ensure that no moisture enters the product. This could result in an electrical short circuit.		If foreign objects or liquid accidentally entered the inside the product, do not use the printer. This could result in an electrical shock or fire. Immediately power off the printer and disconnect the power plug from the outlet. Then contact the MUTOH customer support.
	Follow the precautions below when handling the power cord. <ul style="list-style-type: none">• Do not modify power cords.• Do not place heavy objects on power cords.• Do not bend, twist, or pull on power cords.• Do not route power cords near heating equipment.		Follow the precautions below when handling the power plug. <ul style="list-style-type: none">• Do not allow dust or foreign objects to accumulate around the power plug.• Firmly insert the power plug into the wall outlet.



Safety Precautions

Installation

Warning

	<p>Choose the location which satisfies the requirements below:</p> <ul style="list-style-type: none"> • The floor must be level. • Avoid vibration from the neighboring devices. • Low humidity and free from dust. • Less chance of temperature and humidity changes. • Avoid direct sunlight. • Avoid water. • Avoid direct air onto the printer. • Low levels of electromagnetic waves. 		<p>Keep the work area well-ventilated.</p> <p>Odor of UV ink could have adversely impact on health.</p> <p>If you experience headache, fatigue or dizziness, stop your work and immediately get to fresh air. If nausea persists, seek medical advice.</p>
	<p>Before taking out the printer from the packing box, remove the plastic sheet wrapped around the printer first.</p> <p>Failure to do so may cause slip or damage to the product.</p>		
	<p>This equipment is not suitable for use in locations where children are likely to be present.</p>		

Caution

	<p>Next to the UV-LED lamp in the printer, there may be other sources of UV light present in the working environment: sunlight or any form of artificial light. To avoid printer damage (nozzle clogs, operation faults to the maintenance station, print head damage.) caused by unintentional curing by UV light sources present in the working area, please follow these guidelines:</p> <ul style="list-style-type: none"> • Do not install the product in direct sunlight. Make sure to keep the front cover closed unless necessary to open it. • Do not remove the cover. Do not modify this product. The warranty does not cover if the product has been modified or disassembled. 		
	<p>Minimum three people are required for moving this product. When moving, keep this product level.</p>		<p>Do not tilt or turn the product upside down.</p> <p>The ink inside the printer may spill. MUTOH cannot guarantee that the printer can run properly.</p>

For Safe Use

Before Use

Basic Operations

Various Settings

Maintenance



When problems occur

Appendix







Safety Precautions

Handling

Warning

	Do not sit on or place heavy objects on the product. Failure to do so may result in injury from a fall.		Do not touch the moving parts. This may cause injury or damage to the product.
	In case you need to move the printer after ink was filled, move it slowly to avoid impact and risk of ink leakage.		

Caution

	Ultraviolet light (bluish white light) emitted from the UV inkjet printer is minimized to safe levels; however, be aware of the following points when handling the printer. <ul style="list-style-type: none">• Do not stare directly into the gap under the cover, or stare at the ultraviolet light at close range for long periods of time. This may cause eye damage.• Do not expose your skin to ultraviolet light at close range for long periods of time. This may cause skin inflammation.
    	When cleaning, follow these precautions: <ul style="list-style-type: none">• Make sure to wear protective equipment (gloves, goggles or eye protection, protective clothing, mask).• Always follow the steps to perform maintenance.• Always use a new cleaning stick and dampen it with designated maintenance cleaner. Do not use other type of maintenance cleaner. It may cause nozzle clogging.• Do not touch the tip of a cleaning stick with fingers. If finger oil gets on the stick, it will damage the print head.• Do not reuse a cleaning stick. Dust sticking to the stick will cause damage to the print head.

For Safe Use

Before Use

Basic Operations









Various Settings

Maintenance

When problems occur

Appendix









Safety Precautions

	<p>Never touch the print head nozzles when cleaning around the print head. This could damage the print head.</p>		<p>Do not touch the cleaning wiper and the print head capping station with bare hands when cleaning the wiper. If finger oil gets on this, head cleaning cannot be performed properly.</p>
	<p>Before moving this printer, always empty the waste ink tank even moving short distance. Failure to do so may result in damage to the product.</p>		<p>Do not use volatile chemicals such as thinner, benzene or alcohol for cleaning. This will damage the paint on the printer.</p>
	<p>When handling the front cover or the maintenance cover, always use the following safety precautions:</p> <ul style="list-style-type: none"> • Avoid strong airflow from a fan or an air conditioner to install this printer. If not, it may accidentally close the cover. • When opening the cover, make sure the cover does not hit anyone or anything. 		
 	<p>Make sure the print is completely cured before touching. If you are not sure, wear gloves to avoid skin or clothing contact with ink.</p>		<p>Do not attempt the following actions during ink charging:</p> <ul style="list-style-type: none"> • Power off the printer. • Disconnect the power cord. • Open the front cover or the maintenance cover. • Move the printer.

Safety Precautions

Ink and waste fluid

Warning

	The safety concerns involved with using and handling of UV curable ink and waste fluid are detailed in the Safety Data Sheets (SDS). Please carefully read these sheets before handling these liquids.
	<p>Store ink bags and waste fluids in a cool, dark place and avoid direct sunlight.</p> <p>Keep away from</p> <ul style="list-style-type: none"> • children's reach • fire and heat
	<p>Wear protective equipment (gloves, goggles or eye protection, protective mask, protective clothing) when handling ink.</p> <ul style="list-style-type: none"> • Do not touch uncured UV ink with bare hands.
	<p>UV ink curing time varies depending on surface characteristics of media. Especially a print with low ink coverage needs to rest for a while (approximately one hour). When checking that it is cured, make sure to wear protective gloves.</p>
	<ul style="list-style-type: none"> • Especially during operations where ink might contact you (e.g. handling ink or waste fluid, cleaning of print head/cap/wiper), always wear protective equipment (such as solvent-resistant gloves and goggles) to avoid contact with skin or eyes.
	<ul style="list-style-type: none"> • Two types of gloves are supplied with the printer. To avoid ink penetration, please wear rubber gloves (white) over polyethylene gloves (pink). If these gloves are not available, butyl rubber gloves are recommended.
	<ul style="list-style-type: none"> • If glove becomes contaminated with ink, replace with new ones. • If ink gets on skin, immediately wash with soap and plenty of water for 15minutes. Seek medical advice/ attention if irritation or inflammation are present. • If ink gets in eyes, flush eyes with plenty of water for 15minutes and seek medical advice/attention immediately. • If swallowed, rinse mouth immediately and do not induce vomiting. Seek medical advice/attention.
	<ul style="list-style-type: none"> • When disposing of ink, waste fluid collected from the printer, or containers and paper towels with ink adhered, be sure to follow industrial waste disposal contractors, related laws, and local regulations to dispose of them. • Waste fluid from this printer is harmful. Do not allow it to reach sewage or natural water systems. • Use a HDPE container with light blocking properties to store waste liquid. • When storing waste fluid for a long time, slightly loosen the cap on the container to allow air. Do not tightly close it. • Do not mix waste ink with any other chemical substances, not even in small amounts. <p>When mixed with other chemicals (e.g. oxidants), heating may occur.</p>

For Safe Use

Before Use

Basic Operations

Various Settings





Maintenance

When problems occur

Appendix

Safety Precautions

Caution

	<p>Follow these precautions when handling ink bag:</p> <ul style="list-style-type: none">• Do not disassemble• Do not drop or hit <p>This could lead to ink leakage.</p>		<p>Use of non-designated ink could cause printer failure. Mutoh does not cover the cost of repair caused by such use.</p>
	<p>Use inks within its shelf life.</p> <ul style="list-style-type: none">• Using an expired ink could result in damage to the printer.• When expired, replace with a new one even if ink remains in the ink bag.• Dispose of expired ink as industrial waste. Put the emptied ink bag in a plastic bag and dispose of it according to the local regulations.		
	<p>Use MUTOH genuine ink.</p> <p>This printer is designed to deliver best performance by using MUTOH genuine ink. The use of non-genuine ink may affect the printer as well as print quality. This is not covered by the warranty.</p>		

For Safe Use

Before Use

Basic Operations

Various Settings

Maintenance

When problems occur

Appendix

Safety Precautions

Warning labels

Warning labels are affixed to the hazardous area of the printer. Read and follow the instructions on the labels. In case the warning labels came off or get dirty, please contact your local MUTOH dealer for replacement.

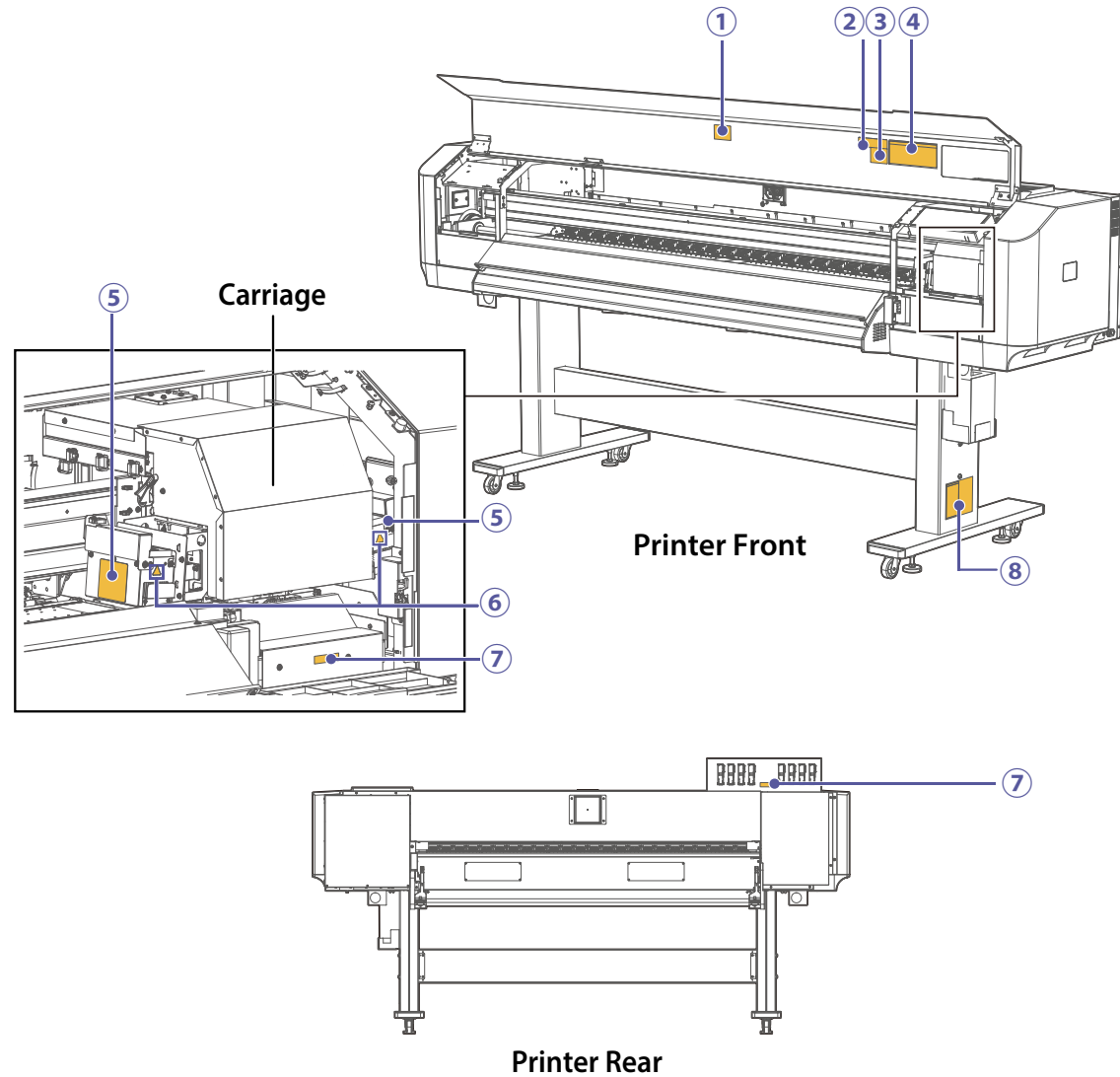

For Safe Use

Before Use

Basic Operations

Various Settings

Maintenance

When problems occur

Appendix

Safety Precautions

Type of labels

Name / Meaning

①

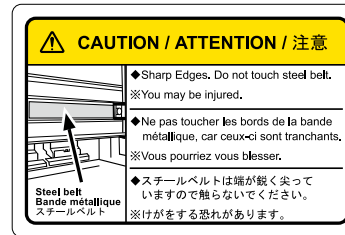

Steel Belt Caution

- Do not touch this part to avoid injury.

②



Cut Hazard Label for Cutter

- Do not insert your fingers around the cutter. The cutting blade may injure your fingers.

③

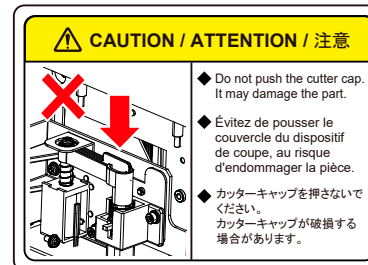

Cutter Cap Caution

- Do not push the cutter cap. This could damage the part.

④

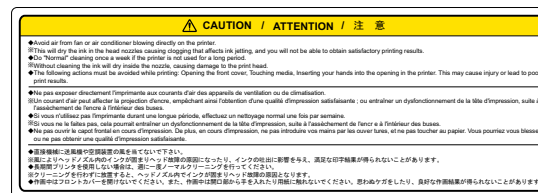

Front Cover Caution

- Follow the instructions on this label.

⑤



UV Safety Label

- UV light hazard: Avoid direct skin or eye exposure to light.

For Safe Use

Before Use

Basic Operations

Various Settings

Maintenance

When problems occur

Appendix

Safety Precautions

Instruction Labels

Instruction labels are affixed where special attention for operating this product is required. The contents of each label are shown here.

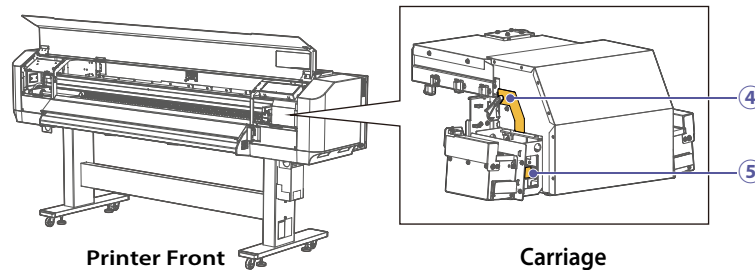
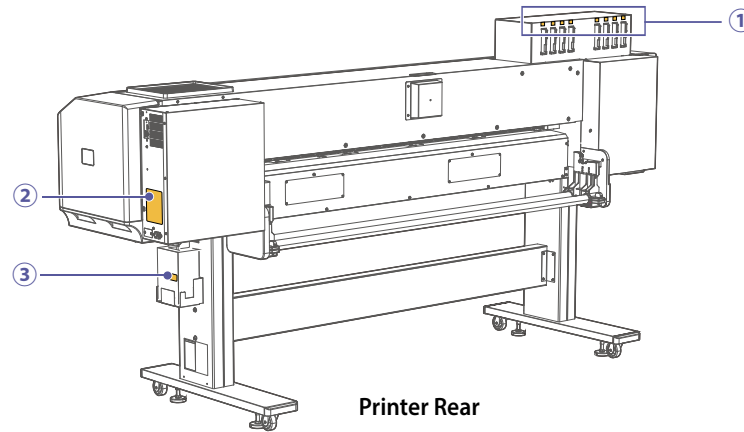

Type of labels

Name / Meaning

①

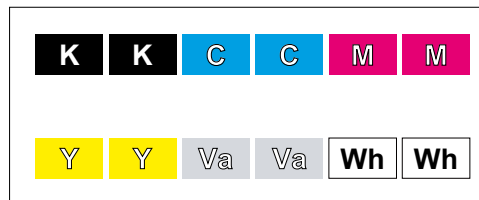

Ink Color Label

Before using this product, apply an ink color label to the area above the ink slot depending on the ink color configuration of your printer.

☞ [“Applying the ink color labels” P.32](#)

Make sure to match the color of the ink to the color on this label and insert the correct ink cartridge (ink bag).

For Safe Use

Before Use

Basic Operations

Various Settings

Maintenance

When problems occur

Appendix

Safety Precautions

②

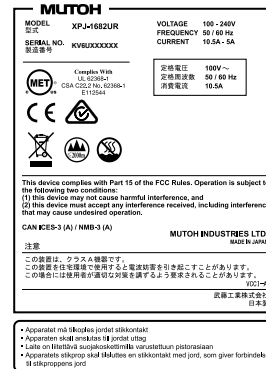

Rating Plate

- Rating Plate provides the model number and serial number of the printer.

③

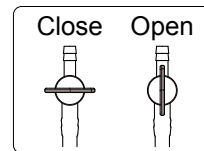

Drain Tube Valve Caution

- The label indicates the open/close position of the drain tube valve.

④

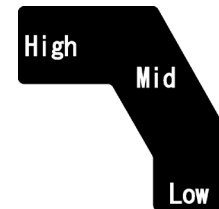

PG Label

- Adjust the print head height by referring to the label.

⑤



ORIGIN Label

- The label indicates the origin position of the printer.

Before Use

Printer main components / Functions	23
Connecting to a computer	33
System configurations of this product	35
Launching/ Opening/ Exiting MSM	36
Installing VerteLith	38
Printing area	39
Supported media	40
Precautions	42

Before Use

Printer main components / Functions

Basic Operations

Connecting to a computer

Various Settings

System configurations of this product

Maintenance

Launching/ Opening/ Exiting MSM

When problems occur

Installing VerteLith

Appendix

Printing area

Supported media

Precautions

Printer main components / Functions

Front view

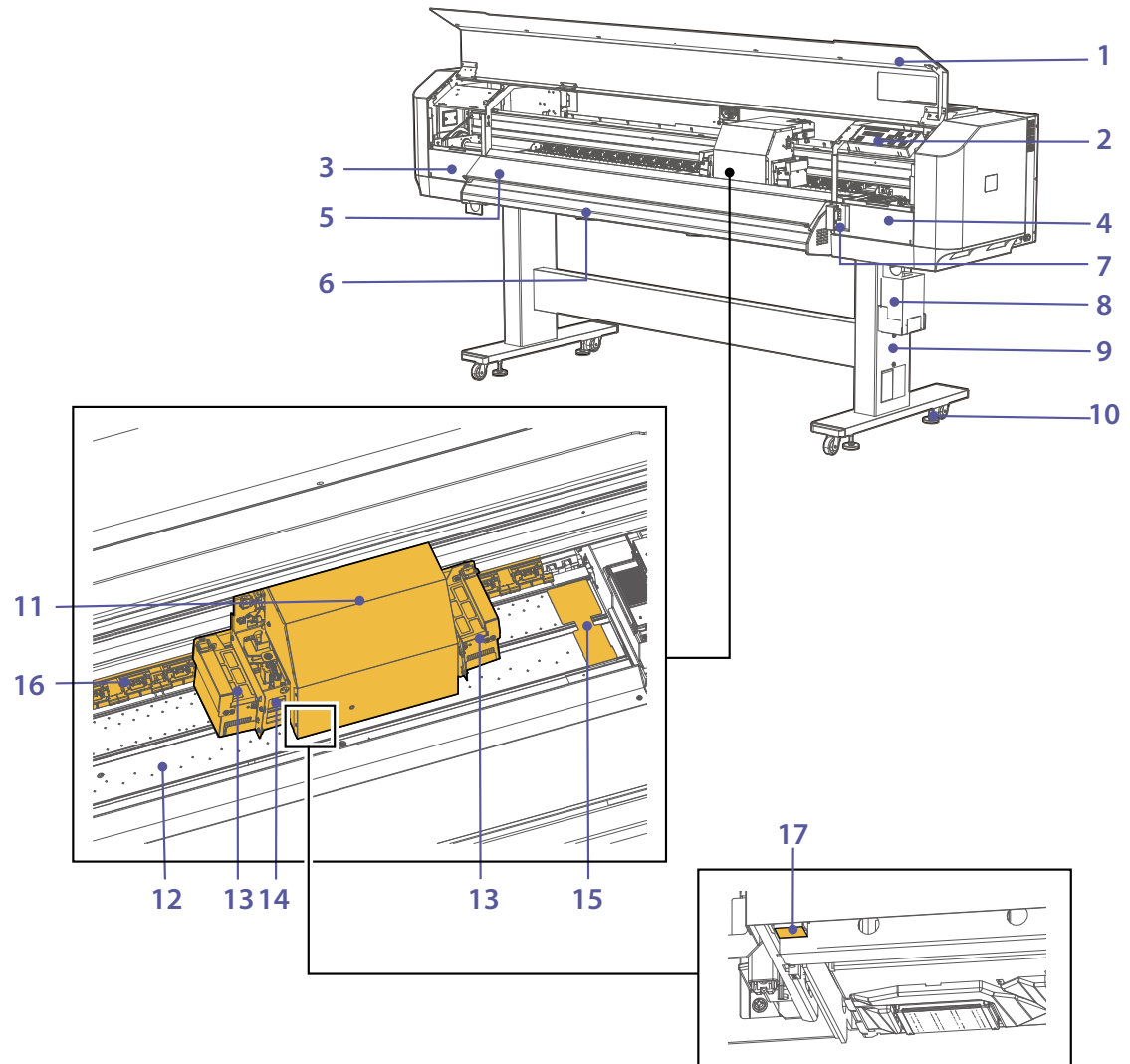

Before Use

Basic Operations

Various Settings

Maintenance

When problems occur

Appendix

Printer main components / Functions

Connecting to a computer

System configurations of this product

Launching/ Opening/ Exiting MSM

Installing VerteLith

Printing area

Supported media

Precautions

1	Front cover	Open or close the cover for maintenance. Normally it is closed.
2	Printer control panel	 "Printer control panel" P. 27
3	Maintenance cover L	Open or close the cover for maintenance or replacement of consumables parts. Normally it is closed.
4	Maintenance cover R	Open or close the cover for maintenance or replacement of consumables parts. Normally it is closed.
5	UV light protective cover	This cover protects eyes from UV light.
6	Media guide	A roll media passes over the media guide.
7	Media feed lever	Push the lever to lower the pressure rollers to keep the media flat while printing. Pull it to release the media. The holddown pressure can be changed between High and Normal using this lever.
8	Waste ink tank	Collects waste fluids from the printer. Empty the tank before it becomes full.
9	Stand	This supports the main body of the printer.
10	Adjuster	This is used to adjust the height of the printer after installation.
11	Carriage	The print head is installed on the carriage.
12	Platen	Media is printed on here. It has a vacuum fan inside.
13	UV-LED lamp	This unit irradiates UV light (ultraviolet light) to cure ink.
14	Cutter	Automatically cut the media after printing.
15	Edge holder	Place it on the edge of the media to prevent media curl while printing.
16	Pressure rollers	Keep the media in place to ensure proper feeding. The holddown pressure can be individually reduced or canceled by slide lock levers on the pressure rollers.
17	Color sensor	This sensor reads the adjustment pattern and the printer automatically runs print head and bidirectional (Adjust Print) calibrations.

Before Use

Basic Operations

Various Settings

Maintenance

When problems occur

Appendix

Printer main components / Functions

Connecting to a computer

System configurations of this product

Launching/ Opening/ Exiting MSM

Installing VerteLith

Printing area

Supported media

Precautions

Rear view

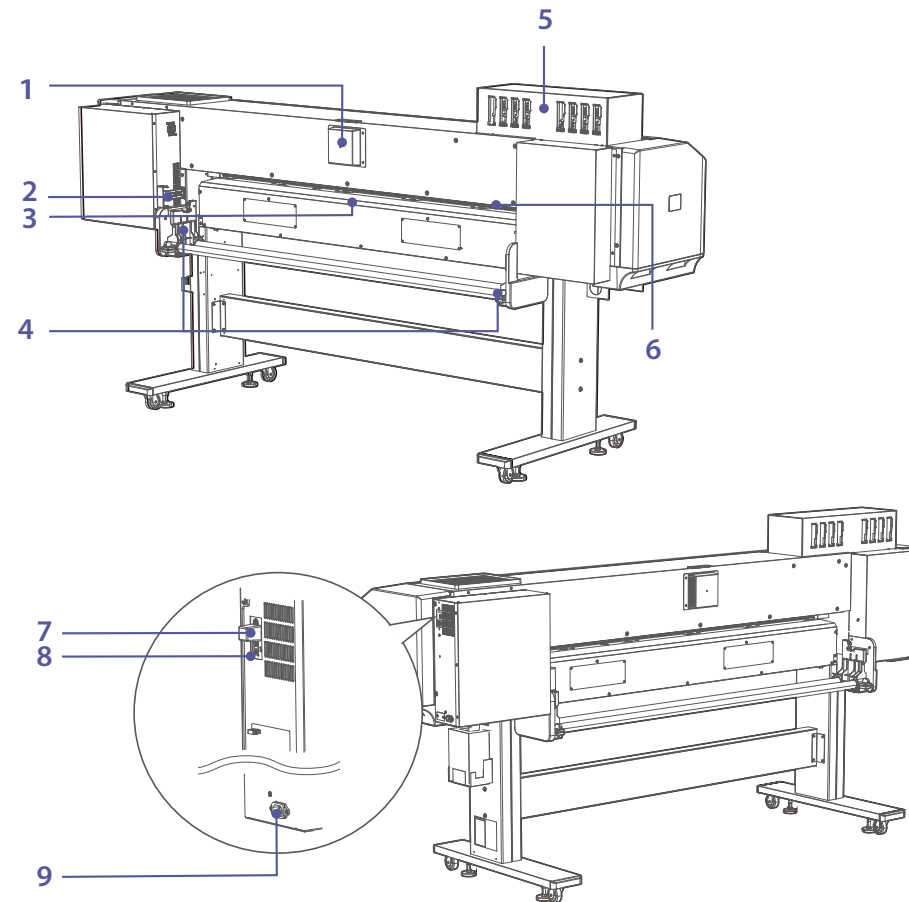

1 Exhaust fan

Remove exhaust from inside the printer.

2 Media feed lever

Hold down or release the media. This lever is interlocked with the media feed lever on the front side.

3 Media guide

Pass a roll media through the media guide.

Before Use

Printer main components / Functions

Basic Operations

Connecting to a computer

Various Settings

System configurations of this product

Maintenance

Launching/ Opening/ Exiting MSM

When problems occur

Installing VerteLith

Appendix

Printing area

Supported media

Precautions

- | | | |
|----------|--|--|
| 4 | Roll media holder | Attach the media flanges to both ends of a roll media and load it onto the roll media holder. |
| 5 | Ink slots | Insert an ink cartridge or a cleaning cartridge into this slot. |
| 6 | Media feed slot | Insert the front edge of the media into this slot and pass it to the front side to load it into the printer. |
| 7 | Take up unit connector (optional) | This is used to connect the take up unit (IJ-TUP30-01) to the printer. |
| 8 | Network interface cable connector | This is used to connect an Ethernet cable to connect the printer to a computer. |
| 9 | AC inlet | This is used to connect the power cord. |

Before Use

Basic Operations

Various Settings

Maintenance

When problems occur

Appendix

Printer main components / Functions

Connecting to a computer

System configurations of this product

Launching/ Opening/ Exiting MSM

Installing VerteLith

Printing area

Supported media

Precautions

Printer control panel

How to operate

The printer has a touch-screen panel located on the front right of the printer. The active keys are lit up on the panel for guidance.

- Tap: Lightly touch the key with your finger, then immediately release.
- Long-touch: Keep touching the key.

Name of parts / Functions

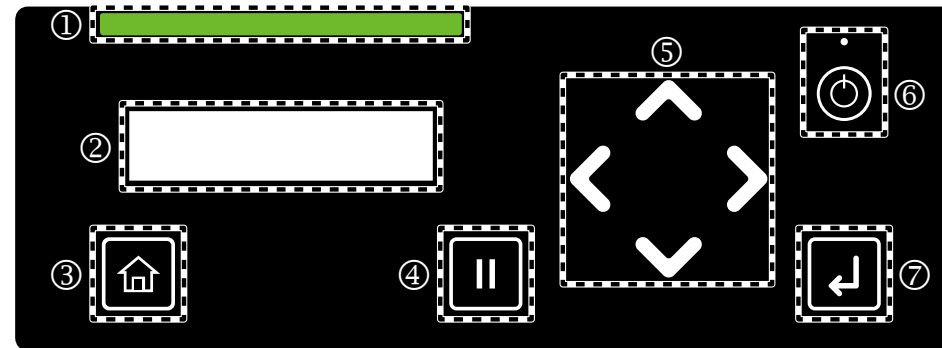

① Status light

Indicates the printer status by LED light.

- Working normally: Solid green
- Error/Alert state: Solid red (error) or flash red (alert)

② Display

Displays the printer status, setting menu, errors and so on.

③



[Home] key :

Tap to access to or exit the setup menu.

④



[Cancel] key :

- Tap to pause printing. Tapping the key again will resume printing.
- Tapping the key while no printing is performed will cut a sheet off the roll media.

Before Use

Printer main components / Functions

Basic Operations

Connecting to a computer

Various Settings

System configurations of this product

Maintenance

Launching/ Opening/ Exiting MSM

When problems occur

Installing VerteLith

Appendix

Printing area

Supported media





Precautions

5







Arrow keys :

In the Setup menu, use these keys to select a menu or enter a value.

-  key: Scroll up the menu list.
-  key: Return to the previous menu without saving the change.
-  key: Go to the next level menu.
-  key: Scroll down the menu list.

In ready-to-print state, use these keys to feed media or perform nozzle check print or cleaning.

-  key: Feed the media backward. Long-touch to feed it with high speed.
-  key: Run a nozzle check print.
-  key: Perform a cleaning cycle.
-  key: Feed the media forward. Long-touch to feed it with high speed.

Note

While the message “Ink-agitate after printing” appears on the control panel,  key is disabled so that you cannot perform cleaning.

6



Power button:

Press and hold the button for more than two seconds to turn on the printer.

The small LED above the button will turn on white.

While the printer is turned on, press and hold the button for more than two seconds to turn off the printer. The LED above the button will turn off.

Note

The  symbol means standby. This printer consumes some power unless the power cord is disconnected. In this document, this state is referred to as the power being “off”. The small LED above the Power button turns on when the power cord is plugged into an outlet.

7



[Enter] key:

Tap to confirm the menu or the value selected.

Tapping the [Enter] key while “Print Ready” or “Media End” is displayed will move to the menu that you can check the time until the next time ink agitation is required.

Before Use

Basic Operations

Various Settings

Maintenance

When problems occur

Appendix

Printer main components / Functions

Connecting to a computer

System configurations of this product

Launching/ Opening/ Exiting MSM

Installing VerteLith

Printing area

Supported media

Precautions





Direct keys

While the following messages appear on the printer control panel (ready to print state), you can directly access to some of the menus by tapping the following keys.

Print Ready 
PG:Low W:1625mm

◀ key

When media is loaded : Tap to access the nozzle check pattern selection menu.

1. Tap  key → [Start Printing? Nozzle Check F] appears.
 - By tapping  the display will return to [Print Ready].
2. Use  /  key to select a nozzle check pattern you want to print.
3. Tap  [Enter] key to print a selected nozzle check pattern.





Note

There are three types of nozzle check patterns.

 ["Run a nozzle check" P.61](#)

▶ key

Tap to access to the cleaning start menu.

1. Tap  key → [Clean Print Head? Short] appears.
 - By tapping  the display will return to [Print Ready].
2. Use  /  key to select a cleaning mode.
3. Tap  [Enter] key so that the printer begins cleaning.

Note

From this direct key, three cleaning modes are available; Short, Normal, Long.

 ["Perform a head cleaning" P.65](#)

⏏ [Cancel] key

Tap to access the Cut Media menu. For details, see ["Cutting media" P.100](#)

⬆ / ⬇ key

Tap to feed media. For details, see ["Feeding media" P.97](#)

Before Use

Printer main components
/ Functions

Basic Operations

Connecting to a computer

Various Settings

System configurations
of this product

Maintenance

Launching/ Opening/
Exiting MSM

When problems
occur

Installing VerteLith

Appendix

Printing area

Supported media

Precautions

[Enter] key

Tap to display the time until the next ink agitation is required.

For details, see [“Agitating ink from the direct key” P.150](#)

You can also check the time until the next ink agitation is required on VerteLith or MSM.

VerteLith : Ver8.2.0 or later

MSM : Ver9.01 or later

Before Use

Printer main components / Functions

Basic Operations

Connecting to a computer

Various Settings

System configurations of this product

Maintenance

Launching/ Opening/ Exiting MSM

When problems occur

Installing VerteLith

Appendix

Printing area

Supported media

Precautions

Ink level indicator on the printer control panel



Indicators of the ink levels or presence of the ink cartridges appear on the display when

- no menu is displayed on the control panel
- ink or ink cartridge error occurs

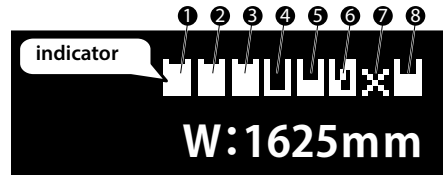
Corresponding ink slot number

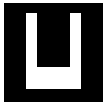

- Indicators correspond to each ink slot ; slot 1 to slot 8. The Left-most indicator is slot 1.
- Each indicator has the following meaning:

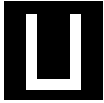
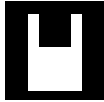
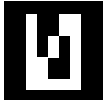
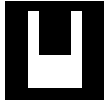
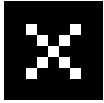
	Ink level 80% to 100%		Ink level 19% or less The indicator blinks when the smartchip recovery is being performed on the corresponding ink. "Smartchip recovery" P.237
	Ink level 60% to 79%		Ink is low
	Ink level 40% to 59%		Ink is out
	Ink level 20% to 39%		No ink cartridge is installed

Before Use

Basic Operations

Various Settings

Maintenance

When problems occur

Appendix

Printer main components / Functions

Connecting to a computer

System configurations of this product

Launching/ Opening/ Exiting MSM

Installing VerteLith

Printing area

Supported media

Precautions

Applying the ink color labels

When looking from the rear of the printer, the slot number and the ink color assignment are shown below.

	Slot1	Slot2	Slot3	Slot4	Slot5	Slot6	Slot7	Slot8
6 colors	K	M	C	Y	Va	Va	Wh	Wh
4 colors	M	M	C	C	K	K	Y	Y

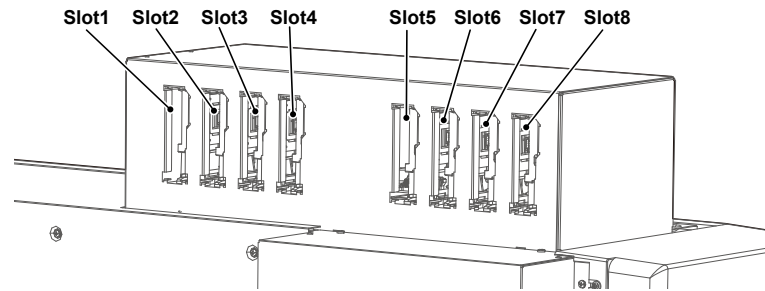

Before Use

Printer main components / Functions

Basic Operations

Connecting to a computer

Various Settings

System configurations of this product

Maintenance

Launching/ Opening/ Exiting MSM

When problems occur

Installing VerteLith

Appendix

Printing area

Supported media

Precautions

Connecting to a computer

Important !!

Make sure your computer meets the following requirements.

- OS: Windows 11, Windows 10
- CPU: Intel (R) Core (TM) i5 or more
- Memory: 8GB minimum
- Network: Use a network port that supports Gigabit Ethernet, and an Ethernet cable that supports Category 6 Gigabit Ethernet or later.

Note

- The OS support period of MUTOH software follows the Microsoft support lifecycle policies.
- When using RIP software, please also check the system requirements of your RIP software.

1 Connect the Gigabit Ethernet cable to the printer.

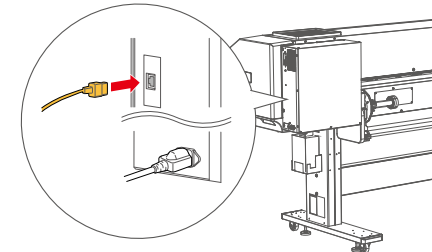

2 Insert the tip of the cable tie into the hole on the printer to attach it.

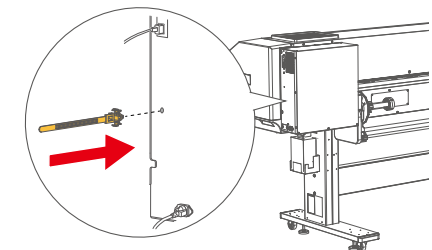

Before Use

Printer main components / Functions

Basic Operations

Connecting to a computer

Various Settings

System configurations of this product

Maintenance

Launching/ Opening/ Exiting MSM

When problems occur

Installing VerteLith

Appendix

Printing area

Supported media

Precautions

- 3 Use the cable tie to secure the Ethernet cable to the printer.

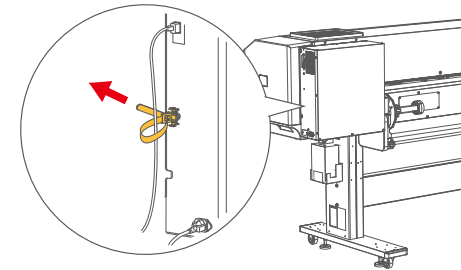

- 4 Connect the Gigabit Ethernet cable to the computer.

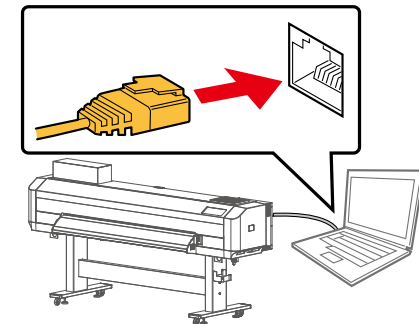

- 5 Use the printer control panel to assign the IP address, subnet mask and gateway.
☞ "IP Address" P.118 , "Subnet Mask" P.118 , "Gateway" P.118

Note

- The illustration above shows the peer-to-peer connection between this product and computer. The connection method varies depending on your environment.
- If you are using the LAN connection, make sure that your printer and computer are on the same subnet.

Before Use

Printer main components / Functions

Basic Operations

Connecting to a computer

Various Settings

System configurations of this product

Maintenance

Launching/ Opening/ Exiting MSM

When problems occur

Installing VerteLith

Appendix

Printing area

Supported media

Precautions

System configurations of this product

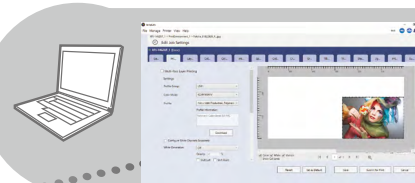
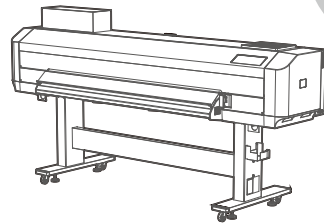

VerteLith

MUTOH original RIP software. It converts images created with graphic design software into a format that can be printed and sends to a printer.



MUTOH Status Monitor (MSM)

Offers wide range of service including

- monitor printer status, ink level and media remaining in real time.
- control your printer through remote panel.
- perform printer maintenance

By signing up for MUTOH Club, you can get the latest service.

*Some of the service require internet access.



Internet

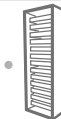

MUTOH Club server

Log into MUTOH Club*.

<https://mutoh-club.com/mutoh/guser/>

* MUTOH Club

By signing up for MUTOH Club, it offers free useful contents including

- download the latest version of application, operation manual
- download media profile
- check printer information

(printer information uploaded through MSM can be viewed)

<Print Support Software>

To get the best out of this product, use the MUTOH Status Monitor (MSM).

You can download the latest version of MSM from the MUTOH Club Server. (To use MPS, specify the output port of RIP software to MPS.)

Before Use

Printer main components / Functions

Basic Operations

Connecting to a computer

Various Settings

System configurations of this product

Maintenance

Launching/ Opening/ Exiting MSM

When problems occur

Installing VerteLith

Appendix

Printing area

Supported media

Precautions

Launching/ Opening/ Exiting MSM

Launching MSM



Windows 11 / Windows 10

1. Double click the MSM icon on the Desktop.

Note

Launching from the Start Menu of Windows

- Windows 11 / Windows 10

From the [Start] menu, click [All Programs] (or [All Apps]) - [MUTOH] - [MUTOH Status Monitor].

Displaying MSM

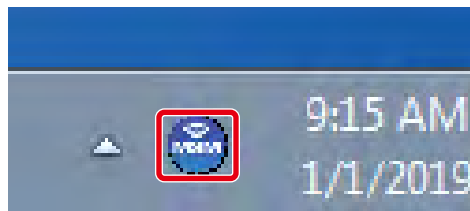

1. Double click the MSM icon in the task tray.

Before Use

Printer main components / Functions

Basic Operations

Connecting to a computer

Various Settings

System configurations of this product

Maintenance

Launching/ Opening/ Exiting MSM

When problems occur

Installing VerteLith

Appendix

Printing area

Supported media

Precautions

Displaying remote panel

The remote panel allows you to view the printer status or remotely operate your printer.

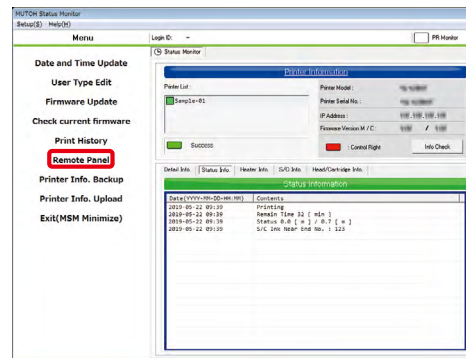

1. Click [Remote Panel].
- The remote panel opens.

Exiting MSM

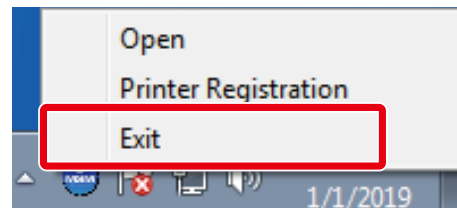

Windows 11 / Windows 10

1. Right click the MSM icon in the task tray, and click [Exit].

Note

While using your printer, do not exit MSM. To close the MSM window, click [Settings] - [Close].

Before Use

Printer main components
/ Functions

Basic Operations

Connecting to a computer

Various Settings

System configurations
of this product

Maintenance

Launching/ Opening/
Exiting MSM

**When problems
occur**

Installing VerteLith

Appendix

Printing area

Supported media

Precautions

Installing VerteLith

After purchasing the license of VerteLith, follow the instructions on Install Guide supplied with the VerteLith package to complete user registration and installation.

Once installed, follow the VerteLith user manual to complete initial setup and printer registration.

Before Use

Printer main components / Functions

Basic Operations

Connecting to a computer

Various Settings

System configurations of this product

Maintenance

Launching/ Opening/ Exiting MSM

When problems occur

Installing VerteLith

Appendix

Printing area

Supported media

Precautions

Printing area

The printer always starts printing from the Origin position (print start point) with following margin on all sides of a page as shown here.

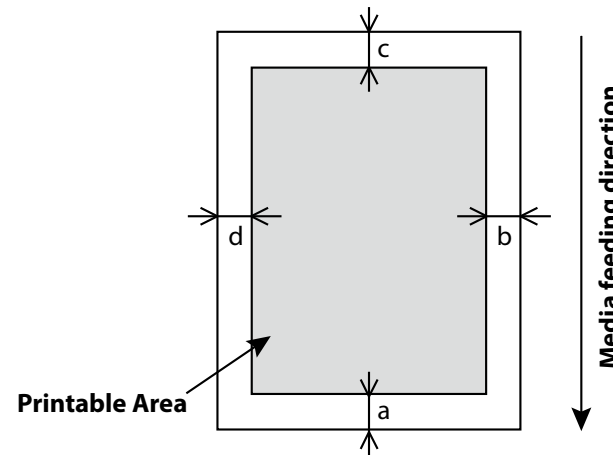

$a=5\text{ mm}^{*1}$

$b=5\text{ mm to }80\text{ mm}^{*2}$

$c=5\text{ mm}$

$d=5\text{ mm to }80\text{ mm}^{*2}$

^{*1} The margin will be 15 mm in the following cases:

- The first printing after media initialization
- When feeding the media backward by using 

The margin will be 40 mm in the following cases:

- When the Media Initial menu is set to "Top&Width"
- After cutting the media

^{*2} Margin can be changed from the Side Margin menu.

Before Use

Printer main components / Functions

Basic Operations

Connecting to a computer

Various Settings

System configurations of this product

Maintenance

Launching/ Opening/ Exiting MSM

When problems occur

Installing VerteLith

Appendix

Printing area

Supported media

Precautions

Supported media

Media that meet the requirements below can be used on this printer.

Media size

Roll media diameter	200 mm maximum
Media core diameter	2 inches: 50 mm to 52 mm 3 inches: 75.5 mm to 79 mm
Weight	up to 30 kg
Width	500 mm to 1,625 mm
Recommended media thickness	up to 1.0 mm

Important !!

The default head height is set to "Low".
In the "Low" setting, media up to 0.3 mm thick can be loaded on the printer.

Note

For recommended media, please contact your local MUTOH dealer.

Before Use

Printer main components / Functions

Basic Operations

Connecting to a computer

Various Settings

System configurations of this product

Maintenance

Launching/ Opening/ Exiting MSM

When problems occur

Installing VerteLith

Appendix

Printing area

Supported media

Precautions

Media handling cautions

Note the following points when handling the media.

- Use the media under an appropriate environment. The appropriate temperature and humidity for printing are as follows.

Recommended Printing Environment	Temperature 22 to 30 °C Humidity 40 to 60%, No condensation
---	--

Change rate	Temperature: No more than 2 °C per 1 hour Humidity: No more than 5% per 1 hour
--------------------	---

- Use media with no fold, scratch, tear or curl.
- The size of media can change according to changes in humidity in the printing environment. Before using media, leave media for 1 hour in the printing environment to adapt it to the environment. Performing printing without adapting media to the printing environment may cause media jams due to gaps or wrinkles in the media. Print quality is also affected.
- When using the printer in a low-humidity environment, the cut media may get stuck and may not come down. In such a case, open the front cover after the media is cut to remove the media.
- Do not use heat-sensitive media. It will deform during ink curing by UV light.
- Do not touch the print side. Moisture and oil on your hands may affect the print quality.
- Do not leave media loaded in the printer for a long time. Some media has a tendency to bend, causing media jams and degradation of print quality. Avoid using such media especially in winter or in dry conditions.
- Printing on a light reflective material may have a chance to cure the ink on the print head, causing malfunction or damage to the printer.
- Do not discard the original packaging box and plastic bag of roll media. You will use them for storing media.

Precaution on storing media after use

When storing roll media after use, follow these precautions to avoid print defects caused by cockling.

- After removing your roll media from the media flange, wind it back onto the roll properly and put it in the original plastic bag. Then store it in the package it came in.
- Avoid high temperature, high humidity, and direct sunlight when storing media.
- Keep the media dry.

Before Use

Printer main components / Functions

Basic Operations

Connecting to a computer

Various Settings

System configurations of this product

Maintenance

Launching/ Opening/ Exiting MSM

When problems occur

Installing VerteLith

Appendix

Printing area

Supported media

Precautions

Precautions

Do not power off the printer

This printer must be powered on all the time. While not in use, make sure to put it into sleep mode. Do not power off or disconnect the power cord. Failure to do so will cause ink settling, leading to print defects or printer failure.

Please use this printer regularly

Mutoh recommends to use this printer at least once a week.

If the printer is not used for a long time, the print head could get clogged, causing damage to the printer.

Please conduct maintenance regularly

This product requires regular user maintenance.

- Run a nozzle check before printing. If the nozzles are clogged, run a head cleaning.
- Make sure to perform a daily maintenance after printing for a day. Failure to perform daily maintenance could cause print defects or printer failure.
☞ [“Daily maintenance at the end of work” P.171](#)
- If you are not using the printer for an extended period*, put it into sleep mode and perform followings:
*Extended period means one week to one month.
 - Check the ink level. If the message [Ink Low] appears, replace with a new ink cartridge (ink bag).
 - If you may not be able to perform above, follow the instruction on [“When not using the printer for a long period of time” P.216](#) to power off the printer.
 - Empty the waste ink tank when needed.
 - Clean the interior of the printer once a month.

Before Use

Printer main components / Functions

Basic Operations

Connecting to a computer

Various Settings

System configurations of this product

Maintenance

Launching/ Opening/ Exiting MSM

When problems occur

Installing VerteLith

Appendix

Printing area

Supported media

Precautions

Some parts need to be replaced periodically

In this product, the following parts must be replaced after a long-term use.

- User replaceable parts:
Absorption material for the flushing box, Cutter, Cleaning wiper, absorption material for the wiper, UV-LED lamp filter, emitting window glass of the UV-LED lamp, Exhaust fan filter
- Parts required to be replaced by service personnel:
Motors, Pumps, Print heads

Use the product in a place that meets “Environmental Requirements”

- Print quality may decrease due to alteration of ink or poor ink curing.
 [“Specifications” P.253](#)

Basic Operations

Printing workflow	45
Powering ON / OFF	46
Loading a roll media into the printer	49
Nozzle check and cleaning	61
Calibrating your printer	67
Start printing	84
Advanced settings	90
Operating from the printer control panel	97
Sleep Mode	103

Before Use

Basic Operations

Various Settings

Maintenance

When problems occur

Appendix

Printing workflow

Powering ON / OFF

Loading a roll media into the printer

Nozzle check and cleaning

Calibrating your printer

Start printing

Advanced settings

Operating from the printer control panel

Sleep Mode

Printing workflow

The following is the basic operation flow for printing.

1. Turn on the printer.

 ["Turning the power ON" P.46](#)

2. Load media into the printer.

 ["Loading a roll media into the printer" P.49](#)

3. Run a nozzle check (perform cleaning if needed).

 ["Nozzle check and cleaning" P.61](#)

4. Perform print head and bidirectional calibrations (if needed).

 ["Calibrating your printer" P.67](#)

5. Print a design.

- We will introduce the printing procedure using MUTOH RIP software "VerteLith".

 ["Start printing" P.84](#)

6. End the printing operation.

 ["Daily maintenance at the end of work" P.171](#)

Before Use

Printing workflow

Basic Operations

Powering ON / OFF

Various Settings

Loading a roll media into the printer

Maintenance

Nozzle check and cleaning

When problems occur

Calibrating your printer

Appendix

Start printing

Advanced settings

Operating from the printer control panel

Sleep Mode

Powering ON / OFF

Turning the power ON

- 1 Close the front cover.
- 2 Press and hold the Power button for more than two seconds.
 - All the key light up.
 - Printer initialization begins.
 - When the message [Welcome] appears on the display, release the button.

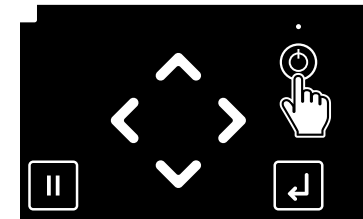

Before Use	Printing workflow
Basic Operations	Powering ON / OFF
Various Settings	Loading a roll media into the printer
Maintenance	Nozzle check and cleaning
When problems occur	Calibrating your printer
Appendix	Start printing
	Advanced settings
	Operating from the printer control panel
	Sleep Mode

Turning the power OFF

Important !!

This printer must be powered on all the time. While not in use, put it into sleep mode .

- Failure to do so may result in ink settling, causing print defects or printer failure.

☞ "Sleep Mode" P.103

If you are not using the printer for an extended period (maximum of one month), follow the steps "When not using the printer for a long time" to turn off the printer.

☞ "When not using the printer for a long period of time" P.216

1 Check that printing has finished and media have been removed from the printer.

2 Prepare the items required for daily maintenance.

☞ "Step 1. Preparations for maintenance" P.172

3 Press and hold the Power button for more than two seconds.

- The message [Daily Maintenance Start -> Enter] appears.

Note

- Tapping  [Cancel] key will turn off the printer without performing a daily maintenance.
- Powering off without daily maintenance could cause nozzle clogging. Normally make sure to perform a daily maintenance.

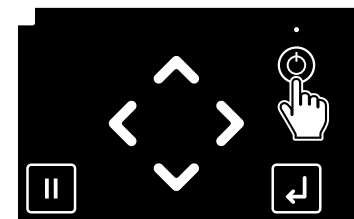

4 Tap  [Enter] key.

- The message [Please Wait] appears.
- The carriage will move to the maintenance position (left side of the printer).

Before Use	Printing workflow
Basic Operations	Powering ON / OFF
Various Settings	Loading a roll media into the printer
Maintenance	Nozzle check and cleaning
When problems occur	Calibrating your printer
Appendix	Start printing
	Advanced settings
	Operating from the printer control panel
	Sleep Mode

5 When [Daily Maintenance Next -> Enter] appears, you can start a daily maintenance.

Important !!

For maintenance procedure, see the following documents:

 ["Daily maintenance at the end of work" P.171](#)

6 Finish the daily maintenance.

- Check that [Check UV LampR End -> Enter] appears on the control panel.
- Once all the maintenance has finished, tap  [Enter] key.

7 [Please Wait] appears.

- [Cleaning **%] appears and the automatic "Short" cleaning begins.

8 Once the cleaning has finished, the message [Power Off] appears and the printer begins powering off.

Before Use

Printing workflow

Basic Operations

Powering ON / OFF

Various Settings

Loading a roll media into the printer

Maintenance

Nozzle check and cleaning

When problems occur

Calibrating your printer

Appendix

Start printing

Advanced settings

Operating from the printer control panel

Sleep Mode

Loading a roll media into the printer

Important !!

Depending on the size of media, two or more people are required for this task.

Loading a roll media into the printer

Follow these steps below to load a media into the printer.

1. Attaching flanges to the media

Items Required:

- Roll media
- Media flange: × 2

1 Replace the flange adapter depending on the size of paper core of roll media.

■ If you are using 2-inch core roll media
Remove the 3-inch adapter from the media flange.

- ① : Pull two tabs on the adapter outward, then remove it from the flange.
- ② : Pull three tabs on the adapter outward, then remove it from the flange.

Note

- If ② adaptor cannot be removed, turn the handle on the flange anti-clockwise to loosen (see Step 2), then remove it.
- If you are using 3-inch core roll media, skip this step.

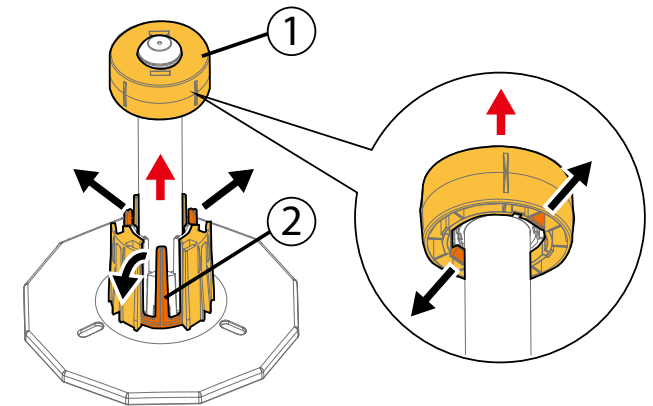

Before Use

Printing workflow

Basic Operations

Powering ON / OFF

Various Settings

Loading a roll media into the printer

Maintenance

Nozzle check and cleaning

When problems occur

Calibrating your printer

Appendix

Start printing

Advanced settings

Operating from the printer control panel

Sleep Mode

■ When replacing 2-inch core roll media with 3-inch core roll media

Attach the 3-inch adapters to the media flange.

- ① : Align the tabs (x3) on the adapter with the dents on the base of flange to click into place.
- ② : Align the notches (x4) on the inside of adapter with the protrusions (x4) on the leading edge of media flange as shown to the right to attach it to the edge of the media flange.

 **Note**

If ② adapter is misaligned, it will not be properly fixed to the media flange.

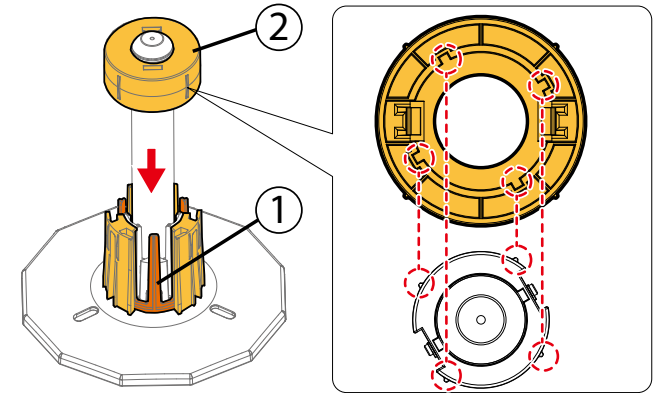

2 Push the media flange (× 2) into the both ends of the media core.

- Before inserting, twist the handle on the flange anticlockwise to unlock it.

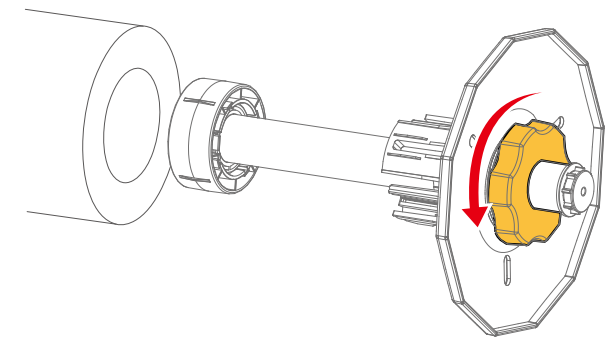

3 Twist the handle clockwise to lock the flange.

 **Important!**

Check that the flange is firmly locked. If not, the media can be removed from the flanges while printing, affecting the print quality.

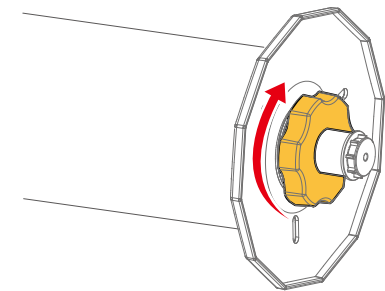

Before Use

Printing workflow

Basic Operations

Powering ON / OFF

Various Settings

Loading a roll media into the printer

Maintenance

Nozzle check and cleaning

When problems occur

Calibrating your printer

Appendix

Start printing

Advanced settings

Operating from the printer control panel

Sleep Mode

2. Enabling torque on media holders

If you want to apply torque to the media holders, follow these steps.

- 1 Twist the knob bolt on the both of the media holder anticlockwise to loosen.

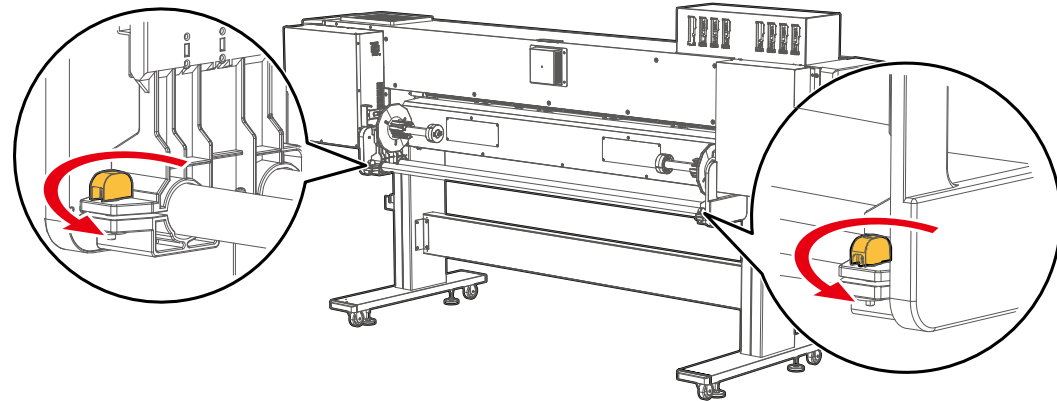

- 2 Slide both left and right media holders about 30 cm towards the center of the slider for easy access.

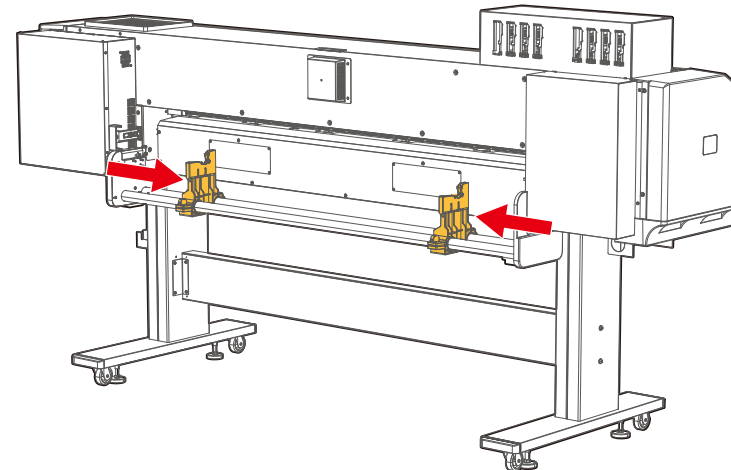

Before Use

Printing workflow

Basic Operations

Powering ON / OFF

Various Settings

Loading a roll media into the printer

Maintenance

Nozzle check and cleaning

When problems occur

Calibrating your printer

Appendix

Start printing

Advanced settings

Operating from the printer control panel

Sleep Mode

3 Tighten the knob bolts on both media holders.

4 (When looking from the rear side of the printer)
Use the screwdriver to loosen four screws securing the roller shaft guide plate to the right media holder.

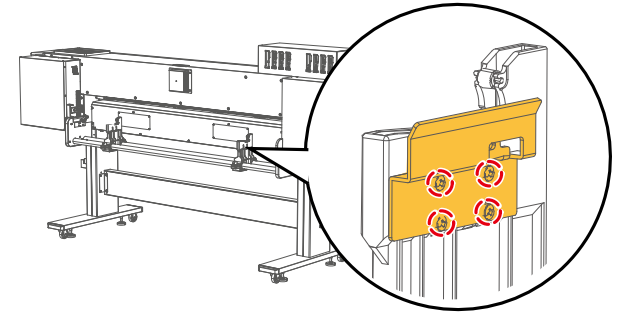

5 Slide up the roller shaft guide plate as far as it will go and tighten the screws.

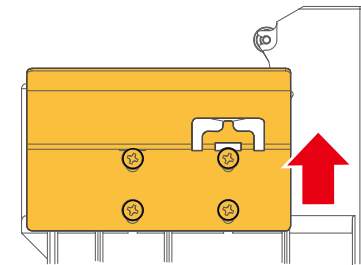

Roller shaft guide plate (right)

6 Do the same for the left media holder to slide up the roller shaft guide plate as far as it will go and tighten the screws.

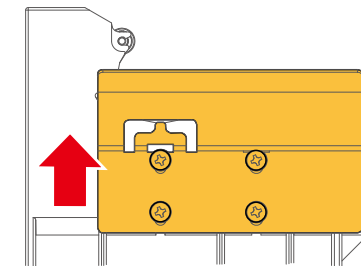

Roller shaft guide plate (left)

Before Use

Printing workflow

Basic Operations

Powering ON / OFF

Various Settings

Loading a roll media into the printer

Maintenance

Nozzle check and cleaning

When problems occur

Calibrating your printer

Appendix

Start printing

Advanced settings

Operating from the printer control panel

Sleep Mode

- 7 Loosen the knob bolts and slide back both media holders to the original position.

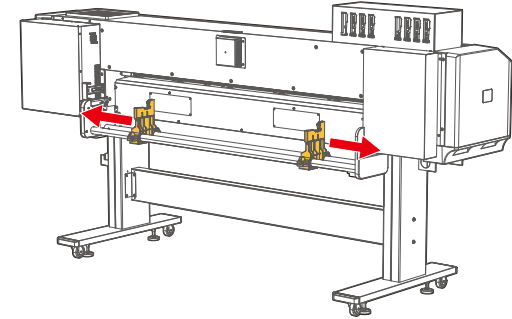

- 8 Tighten the knob bolts on both media holders.

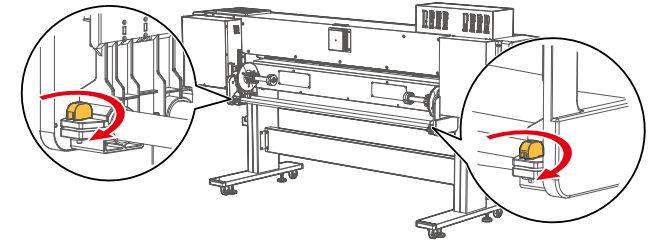

3. Placing the media onto the media holder

- 1 Twist the knob bolt on the right side of the media holder anticlockwise to loosen.

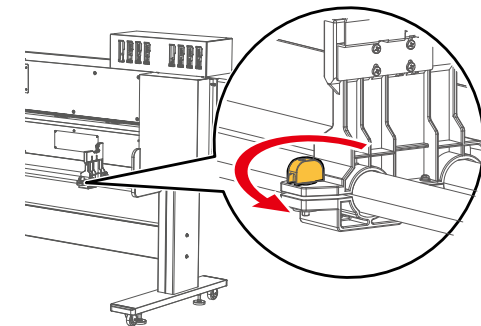

Before Use

Printing workflow

Basic Operations

Powering ON / OFF

Various Settings

Loading a roll media into the printer

Maintenance

Nozzle check and cleaning

When problems occur

Calibrating your printer

Appendix

Start printing

Advanced settings

Operating from the printer control panel

Sleep Mode

2

Place the roll media onto the left media holder. Carefully and gently place it on the holder.

- Place the flange between the roller shaft guide plate and the media holder as shown in the illustration.

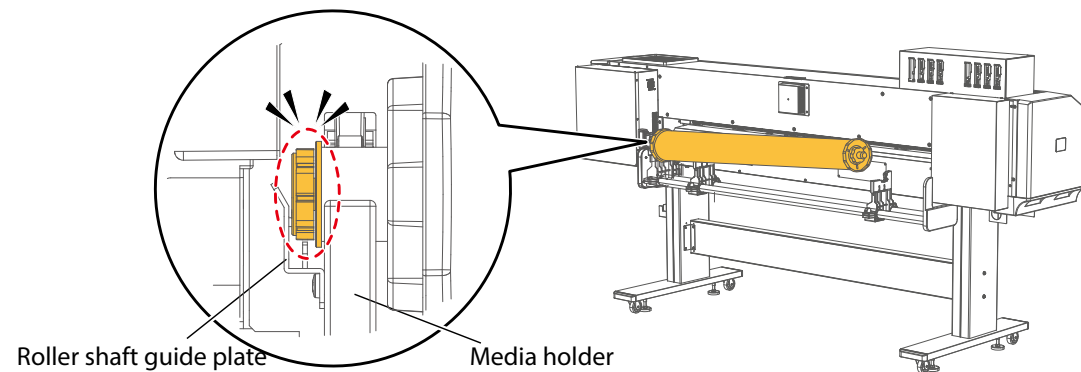

If you set the torque, continue to check the following.

- ① : When looking from the left side, check that the protrusion on the roller shaft guide plate is fitted into between two protrusions on the flange end cap.
- ② : When looking from the rear side of the printer, check that the flange end cap is properly placed on the protrusion on the roller shaft guide plate.

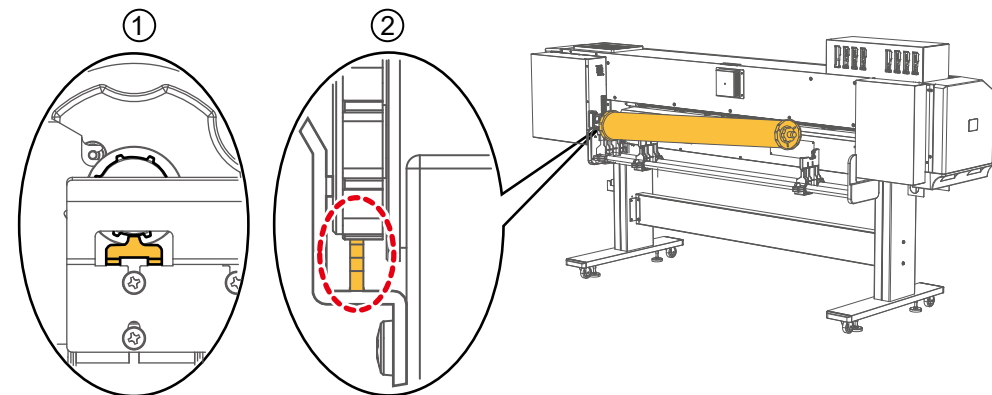

Important!

- Do not drop or apply excessive impact while placing the media. This will cause damage to the part.
- When you adjust the position of the media holder (left), do not move it more than 450 mm away from the left-hand end. The printer will not be able to detect media.

Before Use

Printing workflow

Basic Operations

Powering ON / OFF

Various Settings

Loading a roll media into the printer

Maintenance

Nozzle check and cleaning

When problems occur

Calibrating your printer

Appendix

Start printing

Advanced settings

Operating from the printer control panel

Sleep Mode

3

Place the roll media onto the right media holder. Carefully and gently place it on the holder.

- Slide the right side of the media holder to place the right side of the flange onto the holder.
- Place the flange between the roller shaft guide plate and the media holder as shown in the illustration.

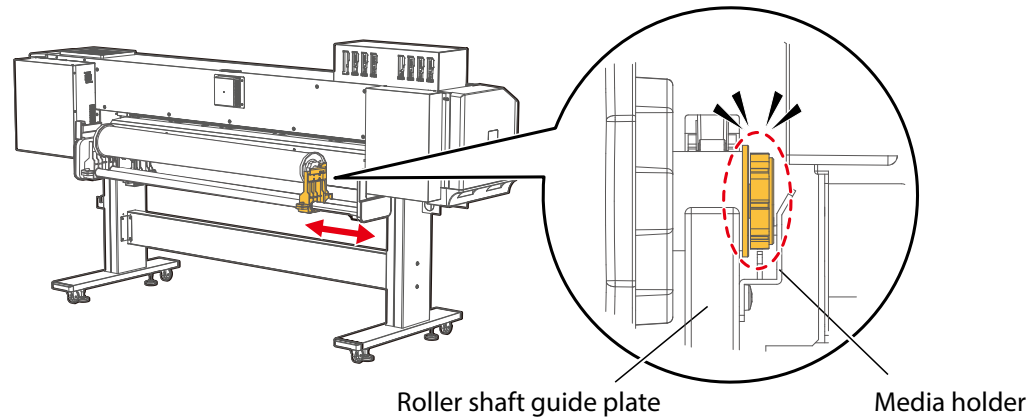

If you set the torque, continue to check the following.

- ① : When looking from the right side, check that the protrusion on the roller shaft guide plate is fitted into between two protrusions on the flange end cap.
- ② : When looking from the rear side of the printer, check that the flange end cap is properly placed on the protrusion on the roller shaft guide plate.

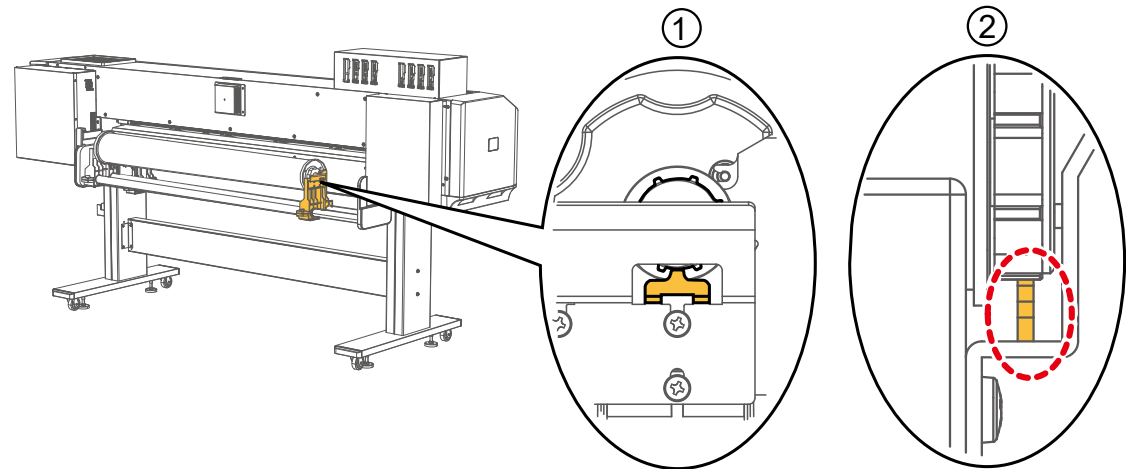

Before Use

Printing workflow

Basic Operations

Powering ON / OFF

Various Settings

Loading a roll media into the printer

Maintenance

Nozzle check and cleaning

When problems occur

Calibrating your printer

Appendix

Start printing

Advanced settings

Operating from the printer control panel

Sleep Mode

- 4 Twist the knob bolt on the right side of the media holder clockwise to tighten.

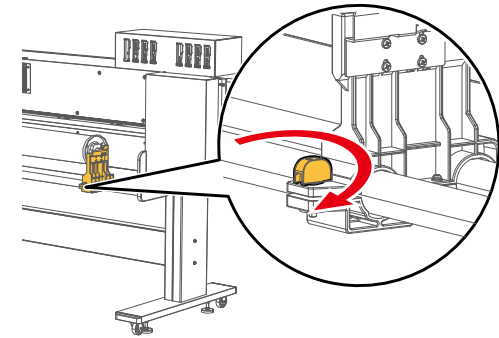

4. Loading the media into the printer

- 1 Check that the printer is powered on.
- 2 From the front side of the printer, fully pull the media feed lever towards you to release the pressure rollers.

You can access to the media feed lever from the rear side of the printer.

- To release the pressure rollers, push the lever as far as it goes.

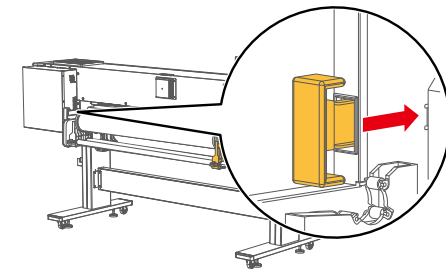
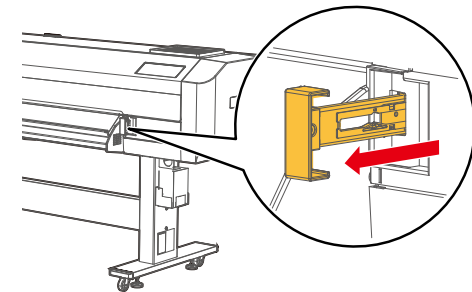

Before Use

Printing workflow

Basic Operations

Powering ON / OFF

Various Settings

Loading a roll media into the printer

Maintenance

Nozzle check and cleaning

When problems occur

Calibrating your printer

Appendix

Start printing

Advanced settings

Operating from the printer control panel

Sleep Mode

3 Open the front cover.

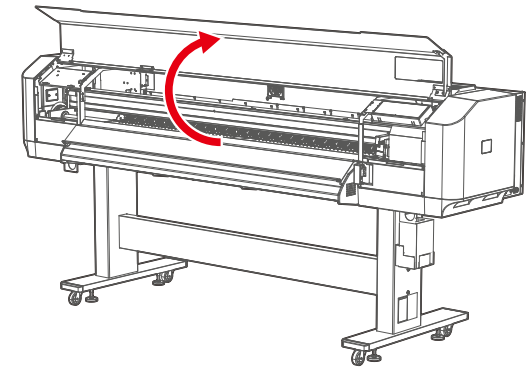

4 From the rear side of the printer, insert the leading edge of roll media into the media slot.

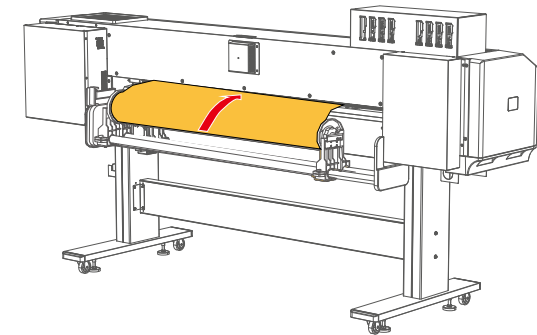

5 From the front side of the printer, pull the media for approximately 1 m.

- Pass the media between the UV light protective cover and the media guide and pull it.

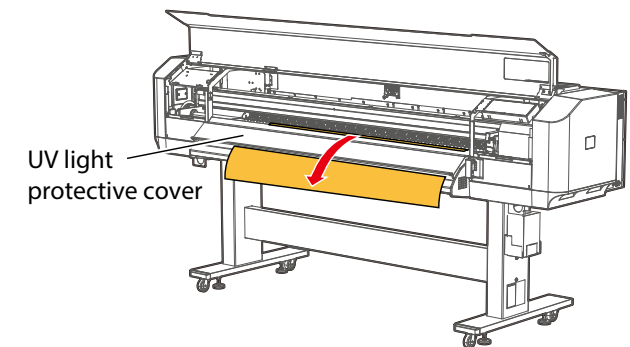

Before Use

Printing workflow

Basic Operations

Powering ON / OFF

Various Settings

Loading a roll media into the printer

Maintenance

Nozzle check and cleaning

When problems occur

Calibrating your printer

Appendix

Start printing

Advanced settings

Operating from the printer control panel

Sleep Mode

- 6 While one person holds the leading edge of the media, the other person turns the flange to slightly rewind the media onto the roll to remove warp or skew.

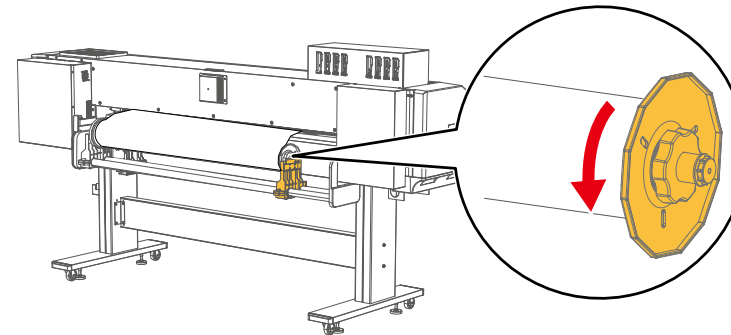

 Note

If you remove your hands from the leading edge of the media while rewinding, the media can be removed from the media slot.

- 7 Check that the right-hand edge of the media is located at the left side of the media guide line. If not, print quality can be affected.

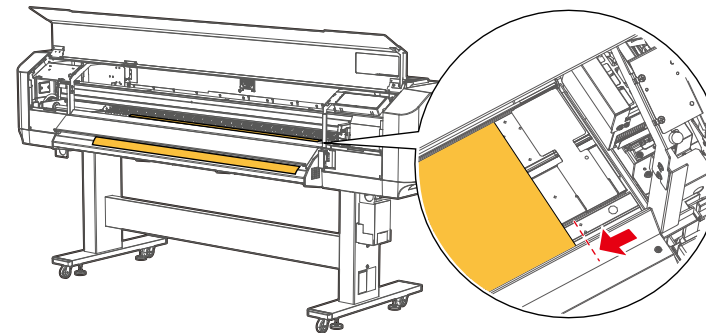

- 8 If needed, use a slide lock lever on the pressure rollers to individually cancel or reduce the pressure.
 "Canceling or reducing pressure rollers individually" P.94

Before Use

Printing workflow

Basic Operations

Powering ON / OFF

Various Settings

Loading a roll media into the printer

Maintenance

Nozzle check and cleaning

When problems occur

Calibrating your printer

Appendix

Start printing

Advanced settings

Operating from the printer control panel

Sleep Mode

5. After loading the media

- 1 From the front side of the printer, push the media feed lever to hold down the media with pressure rollers.

Note

Using this lever, the holddown pressure can be changed between High and Normal. Normally push the lever until it clicks to apply normal pressure.

☞ [“Changing holddown pressure using media feed lever” P.93](#)

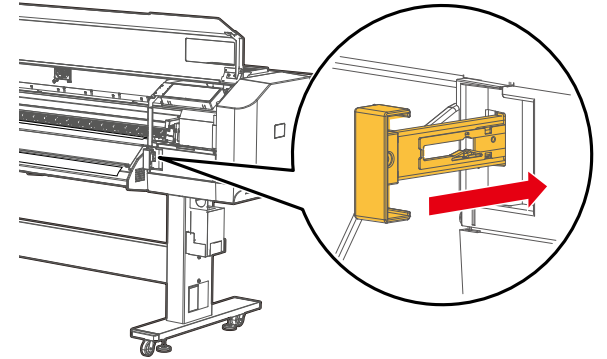

- 2 Check that both edges of the media are held down properly by the pressure rollers.

- If it is held like “No Good” example, pull the media feed lever towards you as much as possible, then adjust the position of the left or right side of the media holder until the both edges of the media are held down properly (see [“3. Placing the media onto the media holder” P.53](#)).

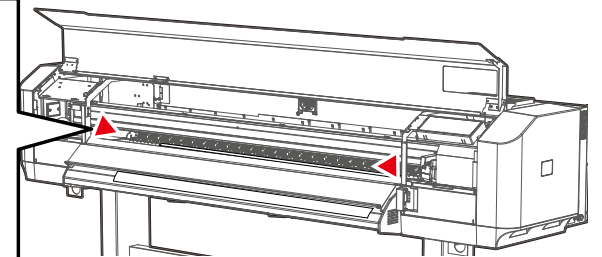
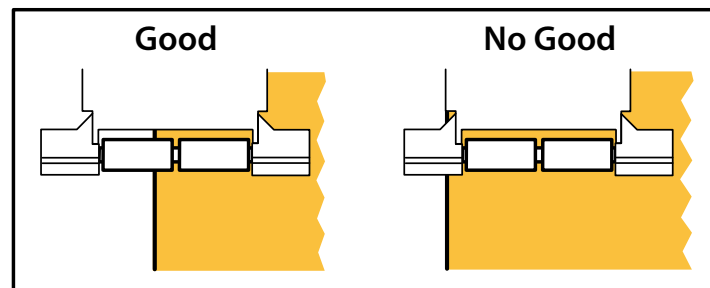

Before Use

Printing workflow

Basic Operations

Powering ON / OFF

Various Settings

Loading a roll media into the printer

Maintenance

Nozzle check and cleaning

When problems occur

Calibrating your printer

Appendix

Start printing

Advanced settings

Operating from the printer control panel

Sleep Mode

3 Place the edge holders on both edges of the media.

- Lift up the tabs on the front of edge holder so that the center of edge holder is lifted. Move and place it on the edge of the media while the center of the edge holder is lifted.

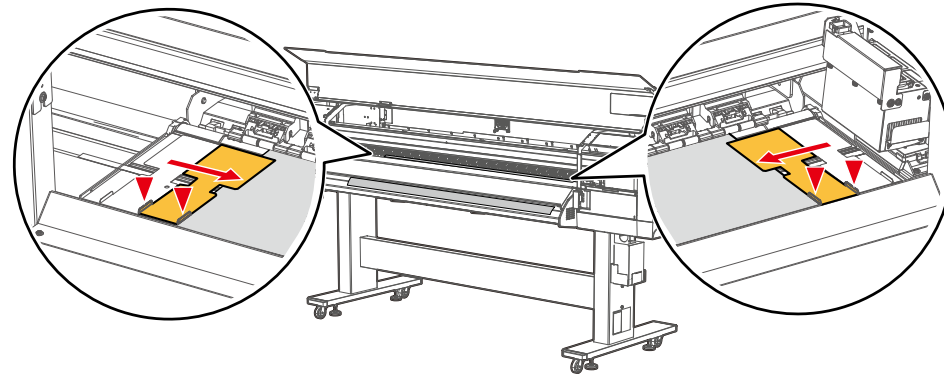

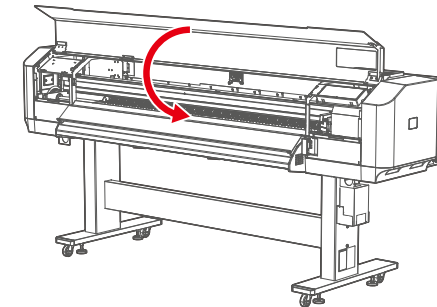

4 Close the front cover.



5 Tap  [Home] key.

6 "User: Type** OK?" appears on the printer control panel.

- Use  or  to choose the correct user type and tap  ([Enter]) to start media initialization.
- End the media loading.

Before Use

Printing workflow

Basic Operations

Powering ON / OFF

Various Settings

Loading a roll media into the printer

Maintenance

Nozzle check and cleaning

When problems occur

Calibrating your printer

Appendix

Start printing

Advanced settings

Operating from the printer control panel

Sleep Mode

Nozzle check and cleaning

Before you start daily printer operation, run a nozzle check. If nozzles are clogged, perform cleaning.

Run a nozzle check

Print the condition of the nozzle to check if all nozzles are firing ink properly.

This printer offers the following nozzle check menus:

Nozzle Check

Prints a nozzle check pattern using the print head and the nozzles selected from the "Advanced Settings: Head Select" and "Advanced Settings: Select Nozzle" menus.

 ["Nozzle check steps" P.62](#)

Nozzle CheckF

Prints a nozzle check pattern using all nozzles.

 ["Nozzle check F steps" P.63](#)

Nozzle CheckB

Some colors of nozzle check patterns are printed with the background colors.

*Displays on 6-color configuration printer only

 ["Nozzle check B steps" P.64](#)

Important !

If you run a nozzle check print immediately after initial ink charging is complete, the following symptom may appear.

- Lines are blurred
- Image is partially not printed

In such cases, go to [Maintenance3 : Cleaning] and perform [Little Charge] cleaning. Then print and check the result. If there is no improvement, leave the printer for at least one hour and then perform cleaning or [Little Charge]. Once finished, print an image again. If the problem still persists, please contact your local MUTOH dealer.

Before Use

Printing workflow

Basic Operations

Powering ON / OFF

Various Settings

Loading a roll media into the printer

Maintenance

Nozzle check and cleaning

When problems occur

Calibrating your printer

Appendix

Start printing

Advanced settings

Operating from the printer control panel

Sleep Mode



Nozzle check steps

1 Load a roll media.

👉 ["Loading a roll media into the printer" P.49](#)

2 Tap .

👉 ["Direct keys" P.29](#)

- When [Start Printing?/ Nozzle Check F] appears, use  /  key to select [Nozzle Check].
- Tap  key so that the printer begins printing a nozzle check pattern.

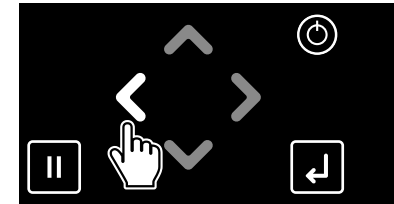

3 Check the nozzle check print to see all nozzles are clear.

- If you find missing or thin lines on the print, go to ["Head Cleaning steps" P.66](#).
- If all lines are clearly printed, you can start printing.

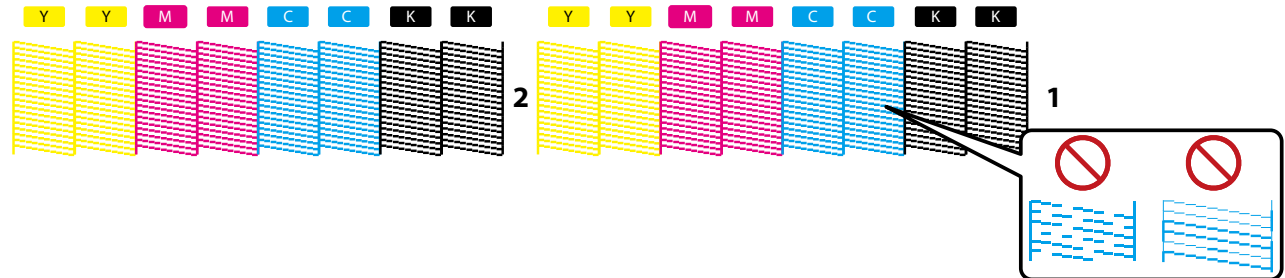

Note

- The above illustration is an example of pattern for 4-color configuration, Head Select: Off, Nozzle Area Select: Nozzle ALL.
- For details of "Head Select", see ["Head Select" P.116](#). For details of "Nozzle Area Select", see ["Select Nozzle" P.116](#)
- Printer information (date and time printed, serial number, firmware version, Head Select setting, Nozzle Area Select setting) is printed next to the pattern.

Before Use

Printing workflow

Basic Operations

Powering ON / OFF

Various Settings

Loading a roll media into the printer

Maintenance

Nozzle check and cleaning

When problems occur

Calibrating your printer

Appendix

Start printing



Advanced settings

Operating from the printer control panel

Sleep Mode

Nozzle check F steps

- 1 Load a roll media.
☞ ["Loading a roll media into the printer" P.49](#)

- 2 Tap .
☞ ["Direct keys" P.29](#)
 - [Start Printing?/ Nozzle Check F] appears.
 - Tap  key so that the printer begins printing a nozzle check pattern.

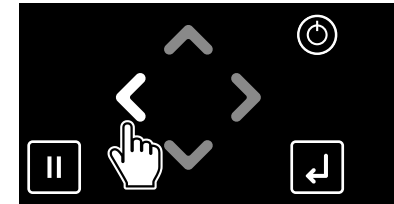

- 3 Check the nozzle check print to see all nozzles are clear.

- If you find missing or thin lines on the print, go to ["Head Cleaning steps" P.66](#).
- If all lines are clearly printed, you can start printing.

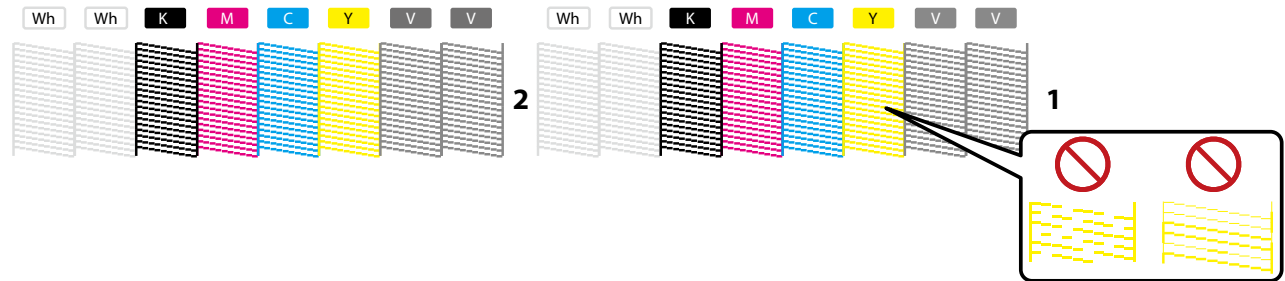

Note

- The above pattern is an example of 6-color configuration.
- Printer information (date and time printed, serial number, firmware version) is printed next to the pattern.

Before Use

Printing workflow

Basic Operations

Powering ON / OFF

Various Settings

Loading a roll media into the printer

Maintenance

Nozzle check and cleaning

When problems occur

Calibrating your printer

Appendix

Start printing





Advanced settings

Operating from the printer control panel

Sleep Mode

Nozzle check B steps

- 1 Load a roll media.
👉 [“Loading a roll media into the printer” P.49](#)

- 2 Tap .
👉 [“Direct keys” P.29](#)
 - When [Start Printing?/ Nozzle Check F] appears, use  /  key to select [Nozzle Check B].
 - Tap  key so that the printer begins printing a nozzle check pattern.

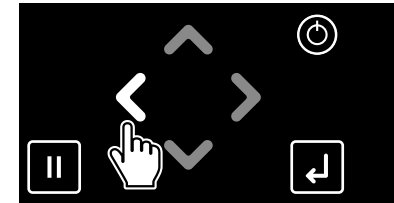

- 3 Check the nozzle check print to see all nozzles are clear.

- If you find missing or thin lines on the print, go to [“Head Cleaning steps” P.66](#).
- If all lines are clearly printed, you can start printing.

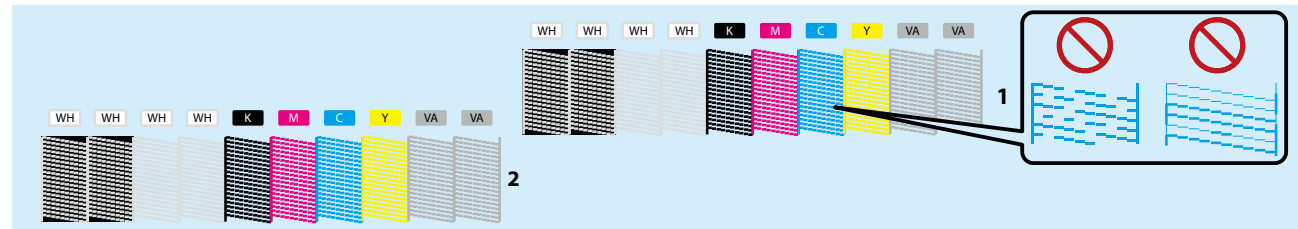

Note

- The above pattern is an example of 6-color configuration. In this example, the area that no background color is printed is shown in blue.
- Printer information (date and time printed, serial number, firmware version, Head Select setting, Nozzle Area Select setting) is printed next to the pattern.

Before Use

Printing workflow

Basic Operations

Powering ON / OFF

Various Settings

Loading a roll media into the printer

Maintenance

Nozzle check and cleaning

When problems occur

Calibrating your printer

Appendix

Start printing

Advanced settings

Operating from the printer control panel

Sleep Mode

Perform a head cleaning

If nozzle clogs, perform a head cleaning.

The following cleaning modes are available in this product. Select an appropriate mode depending on the result of nozzle check print.

Short cleaning	Consumes less ink than "Normal" cleaning.
Normal cleaning	Select this mode if there are several missing lines in the nozzle check print.
Long cleaning	Consumes more ink than "Normal" cleaning. Perform "Long" cleaning if nozzle clogging persists even after "Normal" cleaning was performed.
Little Charge	Gives higher cleaning, but consumes large amount of ink. (To select this menu, go to the "Cleaning" P.126 in the maintenance menu.)
Initial Charge	Offers more powerful cleaning than "Little Charge", but consumes very large amount of ink. (To select this menu, go to the "Cleaning" P.126 in the maintenance menu.)

Important !!

When performing a "Little Charge" or "Initial Charge", please comply with the following. If cleaning is interrupted, it may consume more ink.



- Do not open the front cover and the maintenance cover.
- Do not raise pressure rollers.
- Do not remove ink cartridges (ink bags).
- Make sure to install the new ink cartridges (ink bags).

Before Use	Printing workflow
Basic Operations	Powering ON / OFF
Various Settings	Loading a roll media into the printer
Maintenance	Nozzle check and cleaning
When problems occur	Calibrating your printer
Appendix	Start printing
	Advanced settings
	Operating from the printer control panel
	Sleep Mode

Head Cleaning steps

1 Tap  key.

 ["Direct keys" P.29](#)

2 Use  /  to choose the cleaning mode, then tap  [Enter] key.

Note

From the direct key, three cleaning modes are available; Short, Normal, or Long.

 ["Perform a head cleaning" P.65](#)

3 Tap  [Enter] key.

- The cleaning cycle begins.





4 Run a nozzle check print again.

 ["Run a nozzle check" P. 61](#)

- If the problem persists, repeat normal cleaning.

Note

If missing lines persists after several attempts of "Normal" cleaning, refer to the following coping strategies.

1. Perform the "Long" cleaning. (If the problem persists, go to the next step.)
2. Perform the following cleaning. (If the problem persists, go to the next step.)
 ["Cleaning flow" P.189](#)
3. Go to Maintenance menu > Cleaning menu and perform "Little Charge" cleaning. (If the problem persists, go to the next step.)
 ["Cleaning" P.126](#)
4. Perform the soak cleaning:
 ["Soak Cleaning" P. 186](#)
5. If nozzle still clogs, you can select the nozzles that do not suffer from clogging to continue printing.
 ["Select Nozzle" P.119](#)

Before Use	Printing workflow
Basic Operations	Powering ON / OFF
Various Settings	Loading a roll media into the printer
Maintenance	Nozzle check and cleaning
When problems occur	Calibrating your printer
Appendix	Start printing
	Advanced settings
	Operating from the printer control panel
	Sleep Mode

Calibrating your printer

The following calibration must be performed before you print for the first time.

- **“Print head calibration (“Adjust Head”)” P.68**

This printer has two print heads. This alignment will calibrate dot placement between two print heads. After performing this calibration (“Adjust Head”), you must perform print quality calibration (“Adjust Print”).

- **“Print quality calibration (“Adjust Print”)” P.72**

This calibration will adjust the dot placement in bidirectional printing.

- **“Media feed adjustment” P.78**

This adjustment will correct the media feed amount.

Before Use

Printing workflow

Basic Operations

Powering ON / OFF

Various Settings

Loading a roll media into the printer

Maintenance

Nozzle check and cleaning

When problems occur

Calibrating your printer

Appendix

Start printing

Advanced settings

Operating from the printer control panel

Sleep Mode

Print head calibration ("Adjust Head")

This printer has two print heads. This alignment allows you to check an adjustment pattern printed and calibrate dot placement position between two print heads.

"Adjust Head" has following menus:









Auto	The color sensor reads the adjustment pattern print and the printer runs automatic calibration.
Standard	Print an adjustment pattern and enter the number of the pattern that has least misalignment. This menu adjusts the dot placement position for the print mode specified in the currently selected user type. When you calibrate with this menu, select the same print mode in your RIP software.
Custom	Print an adjustment pattern and enter the number of the pattern that has least misalignment. This menu calibrates the dot placement position for all print modes. Print quality can be optimized even if the print mode selected in the RIP software and the printer are different.

Note

- If the following problem appears, try print head calibration. The print quality may improve.
 - The print quality of bidirectional printing is not good.
 - The print quality does not improve even if the "Adjust Print" calibration was performed.
- After you perform a print head calibration, make sure to perform print quality calibration as well.
 - Misalignment may occur due to the head alignment.
-  ["Print quality calibration \("Adjust Print"\)" P.72](#)
- If you change the print mode after performing "Adjust Head" calibration from the "Standard" menu, make sure to perform "Adjust Head" calibration again.
- If you change the print mode after performing "Adjust Head" calibration from "Custom" "Fine Pattern ALL", there is no need to perform this calibration again as it calibrates dot placement position for all print modes.
- If you want to use the different print mode in your RIP software from the mode specified in the printer control panel, make sure to run the "Adjust Head" calibration from "Custom" to check alignment in all adjustment patterns (A,B,D,E) beforehand.
- If performing the auto calibration does not improve print quality (banding or graininess appears), do an auto calibration again or run the "Adjust Head" calibration from "Standard" or "Custom".
- If a roll media curls or warps, load it into the printer again.

Before Use	Printing workflow
Basic Operations	Powering ON / OFF
Various Settings	Loading a roll media into the printer
Maintenance	Nozzle check and cleaning
When problems occur	Calibrating your printer
Appendix	Start printing
	Advanced settings
	Operating from the printer control panel
	Sleep Mode

Print head calibration steps

- 1 Load a roll media.
 - ☞ ["Loading a roll media into the printer" P.49](#)
 - Make sure to load it without any warps or curls.
- 2 Go to the "Adjust Head" menu.
 - Tap  [Home] key so that [Menu1 Setup] appears.
 - Tap  key to select [Menu2: Test Print].
 - Tap  key so that [Test Print1 Nozzle Check] appears.
 - Use  /  key to select [Test Print7 Adjust Head].
 - Tap  key so that [Adjust Head1 Auto] appears.
- 3 Use  /  to choose the alignment method.
- 4 Follow these steps to run the calibration.
 - ☞ ["Adjust Head : When \[Auto\] is selected" P.70](#)
 - ☞ ["Adjust Head : When \[Standard\] or \[Custom\] is selected" P.71](#)

Before Use	Printing workflow
Basic Operations	Powering ON / OFF
Various Settings	Loading a roll media into the printer
Maintenance	Nozzle check and cleaning
When problems occur	Calibrating your printer
Appendix	Start printing
	Advanced settings
	Operating from the printer control panel
	Sleep Mode

Adjust Head : When [Auto] is selected

For details of adjustment pattern, see the menu table in Various Settings. "Adjust Head" P.125

1 Select an adjustment pattern.

- Tap key so that [ALL] appears.
- Use / key to select an adjustment pattern.
- Tap [Enter] key so that the printer begins printing.

Note

Tapping [Cancel] key while printing a pattern will cancel printing.

2 The color sensor reads the adjustment pattern print and the printer runs automatic calibration.

3 Once the calibration is finished, the message [AutoAdjust Succeeded/OK ->Enter] appears.

- When the calibration is failed, the message [AutoAdjust Failed/ OK -> Enter] appears. Tap [Enter] key to end the calibration.
- Run an [Auto] calibration again or perform [Custom] calibration.

4 Tap key to end the calibration.

Note

- **If failed in the middle of the calibration, the adjustment value for the pattern which has been successfully calibrated will be saved in the printer, but the adjustment value for the pattern which has been failed to calibrate or has not been calibrated yet will not be saved in the printer.**
- **If performing the auto calibration does not improve print quality (banding or graininess appears), run an [Auto] calibration again or perform [Custom] calibration.**
- **If a roll media curls or warps, load it into the printer again.**

Before Use	Printing workflow
Basic Operations	Powering ON / OFF
Various Settings	Loading a roll media into the printer
Maintenance	Nozzle check and cleaning
When problems occur	Calibrating your printer
Appendix	Start printing
	Advanced settings
	Operating from the printer control panel
	Sleep Mode

Adjust Head : When [Standard] or [Custom] is selected

- **Standard:** If the print mode (resolution, number of passes, printing direction) selected in your RIP software is different from the one specified in the selected user type, choose the adjustment pattern that matches the print mode of your RIP software.

☞ ["Adjustment pattern for each print mode" P.77](#)





- For details of adjustment pattern, see the menu table in Various Settings. ☞ ["Adjust Head" P.125](#)

1 Print an adjustment pattern.

- **When [Standard] is selected**

- Tap  [Enter] key so that the printer begins printing a pattern.

- **When [Custom] is selected**

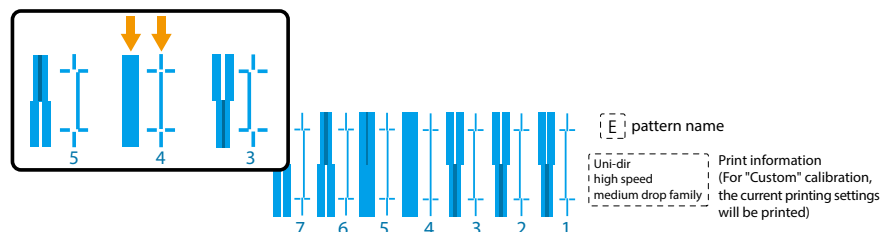

- Tap  key. [Custom1 Fine Pattern ALL] appears.
- Use  /  key to select an adjustment pattern.
- Tap  [Enter] key. The printer begins printing.
- Look at the print and select the pattern that looks most aligned.



Note

Tapping  [Cancel] key while printing a pattern will cancel printing.

2 Enter the number written under the most aligned pattern.

- In the above example, you will enter [Pattern E: 4].
-  /  key : Change the number.
-  [Enter] key : Confirm the change.
- If you have selected [Adjust Head2: Custom] and [Fine Pattern ALL], you will need to select and enter the number from each pattern A, B, D and E.

Before Use	Printing workflow
Basic Operations	Powering ON / OFF
Various Settings	Loading a roll media into the printer
Maintenance	Nozzle check and cleaning
When problems occur	Calibrating your printer
Appendix	Start printing
	Advanced settings
	Operating from the printer control panel
	Sleep Mode

Print quality calibration ("Adjust Print")

This calibration adjusts dot placement position in bidirectional printing. You will need to enter the thickness of media before calibration.

Make sure to run this calibration when

- you use this product for the first time
- you changed to the different types of media

When the following symptom appears, you should run this calibration

- Image looks grainy or lines are blurry in bidirectional printing.

"Adjust Print" has following menus:

Auto	The color sensor reads the adjustment pattern print and the printer runs automatic calibration.
Standard	Print an adjustment pattern and enter the number of the pattern that looks most aligned. This menu calibrates the the dot placement position for the print mode specified in the currently selected user type. When you calibrate with this menu, please select the same print mode in your RIP software.
Custom	Print an adjustment pattern and enter the number of the pattern that looks most aligned. This menu calibrates the dot placement position for all print modes. Print quality can be optimized even if the print mode selected in the RIP software and the printer are different.

Note

- To print an adjustment pattern, more than 550 mm of printable area is required. If less than 550 mm, calibration cannot be performed.
- Changing the origin setting for CR and the left and right side margins with reference to the width of media loaded can increase or decrease the width of printable area.
- ☞ ["Media Width" P.111](#) , ["Origin" P.112](#) , ["Side Margin" P.111](#)
- If you change the print mode after performing "Adjust Print" calibration from the "Standard" menu, make sure to perform "Adjust Print" calibration again.
- If you change the print mode after performing "Adjust Print" calibration from "Custom", there is no need to perform this calibration again as it calibrates dot placement position for all print modes.
- If you want to use the different print mode in your RIP software from the mode specified in the printer control panel, make sure to run the "Adjust Print" calibration from "Custom" to check alignment in the adjustment patterns A, B, D and E beforehand.

Before Use	Printing workflow
Basic Operations	Powering ON / OFF
Various Settings	Loading a roll media into the printer
Maintenance	Nozzle check and cleaning
When problems occur	Calibrating your printer
Appendix	Start printing
	Advanced settings
	Operating from the printer control panel
	Sleep Mode

Print quality calibration steps

- 1 Load a roll media.
["Loading a roll media into the printer" P.49](#)
- 2 Go to the "Adjust Print" menu.
 - Tap [Home] key so that [Menu1 Setup] appears.
 - Tap key twice so that [User Type Type1] appears.
 - Use / key to select a user type you want to use and tap [Enter] key.
 - [Type** : 1 Print Mode] appears.
 - Use / key to select [Type** : 2 : Adjust Print].
- 3 Tap key. [Thickness:] appears.
 - Enter the thickness of roll media.
 - / key: enter a value.
 - [Enter] key: Confirm the thickness.
- 4 [Adjust Print1 Auto] appears.
 - Use / key to select an adjustment method.
 - ["Print quality calibration \("Adjust Print"\)" P.72](#)
- 5 Tap key.
- 6 Follow these steps to perform a calibration.
 - ["Adjust Print: When \[Auto\] is selected" P.74](#)
 - ["Adjust Print: When \[Standard\] or \[Custom\] is selected" P.75](#)

Before Use	Printing workflow
Basic Operations	Powering ON / OFF
Various Settings	Loading a roll media into the printer
Maintenance	Nozzle check and cleaning
When problems occur	Calibrating your printer
Appendix	Start printing
	Advanced settings
	Operating from the printer control panel
	Sleep Mode

Adjust Print: When [Auto] is selected

- For details of adjustment pattern, see the menu table in Various Settings. ["Adjust Print" P.109](#)

1 Select an adjustment pattern.

- Use / key to select an adjustment pattern.
- Tap [Enter] key so that the printer begins printing a pattern.
- The color sensor reads the adjustment pattern print and the printer runs automatic calibration.

Note

Tapping key while printing a pattern will cancel printing.

2 Once the calibration is finished, the message [AutoAdjust Succeeded/OK ->Enter] appears.

- When the calibration is failed, the message [AutoAdjust Failed/ OK -> Enter] appears. Tap [Enter] key to end the calibration.
- Run an [Auto] calibration again or perform [Standard] or [Custom] calibration.

3 Tap [Enter] key to end the calibration.

Note

- If failed in the middle of the calibration, the adjustment value for the pattern which has been successfully calibrated will be saved in the printer, but the adjustment value for the pattern which has been failed to calibrate or has not been calibrated yet will not be saved in the printer.
- If performing the auto calibration does not improve print quality (banding or graininess appears), run an [Auto] calibration again or perform [Custom] calibration.

Before Use	Printing workflow
Basic Operations	Powering ON / OFF
Various Settings	Loading a roll media into the printer
Maintenance	Nozzle check and cleaning
When problems occur	Calibrating your printer
Appendix	Start printing
	Advanced settings
	Operating from the printer control panel
	Sleep Mode

Adjust Print: When [Standard] or [Custom] is selected

- Standard: If the print mode (resolution, number of passes, printing direction) selected in your RIP software is different from the one specified in the selected user type, choose the adjustment pattern that matches the print mode of your RIP software.

☞ [“Adjustment pattern for each print mode” P.77](#)

- For the details of adjustment method, see the menu table in Various Settings. ☞ [“Adjust Print” P.109](#)

1 Print a Confirm Pattern.

- Tap  [Enter] key so that the printer begins printing.

Note

Tapping  key while printing a pattern will cancel printing.

2 Look at the print and check if there is any misalignment.

If no misalignment exists, tap  [Enter] key to end the calibration.

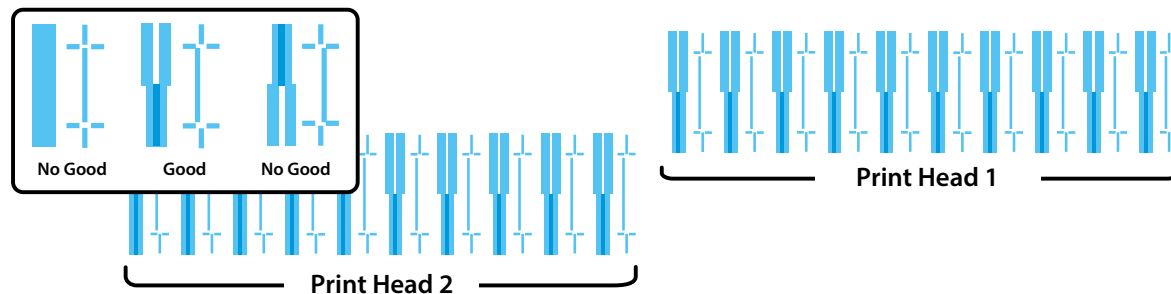

- If the amount of misalignment is large, move to step 3.
- If the amount of misalignment is small, move to step 6.

Before Use

Printing workflow

Basic Operations

Powering ON / OFF

Various Settings

Loading a roll media into the printer

Maintenance

Nozzle check and cleaning

When problems occur

Calibrating your printer

Start printing



Appendix

Advanced settings

Operating from the printer control panel



Sleep Mode

3 Print a rough adjustment pattern.

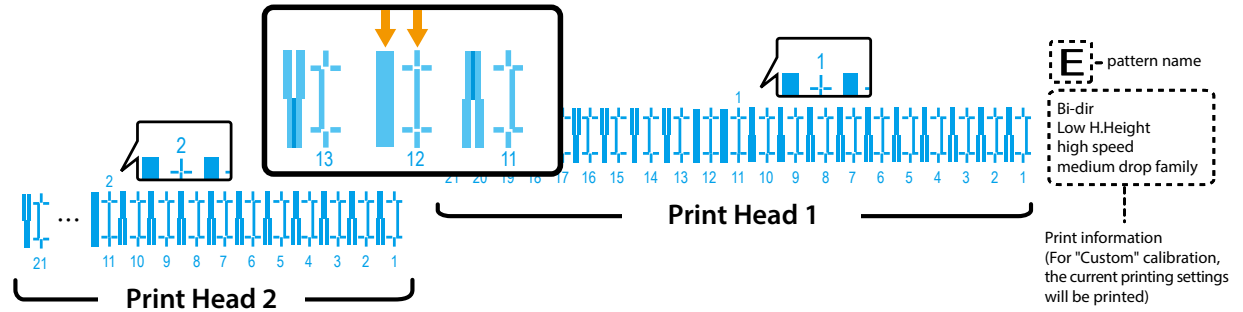
- For "Custom" calibration : Use  /  key to select a pattern from [Rough Pattern ALL], [Rough Pattern A], [Rough Pattern B], [Rough Pattern D] or [Rough Pattern E].
- Tap  key to print it.
- Look at the print for Print Head 1 and select the number written under the pattern that looks most aligned.



4 Enter the number you selected.

- For the illustration in step 3, you will enter [Pattern E1: 12].
-  /  key : change the number.
-  [Enter] key : Confirm the change.
- If you have selected [Adjust Print3: Custom] > [Rough Pattern ALL], you will need to select and enter the number from each pattern A, B, D and E.

5 Follow the steps 3 & 4 to do calibration for Print Head 2.

Before Use

Printing workflow

Basic Operations

Powering ON / OFF

Various Settings

Loading a roll media into the printer

Maintenance

Nozzle check and cleaning

When problems occur

Calibrating your printer

Start printing

Appendix

Advanced settings

Operating from the printer control panel

Sleep Mode

6 Print a fine adjustment pattern.

- For "Custom" calibration : Use / key to select a pattern from [Fine Pattern ALL], [Fine Pattern A], [Fine Pattern B], [Fine Pattern D] or [Fine Pattern E].
- Tap [Enter] key to print it.
- Look at the results for Print Head 1 printed at both ends and the center of media and select the number written under the pattern that looks most aligned.

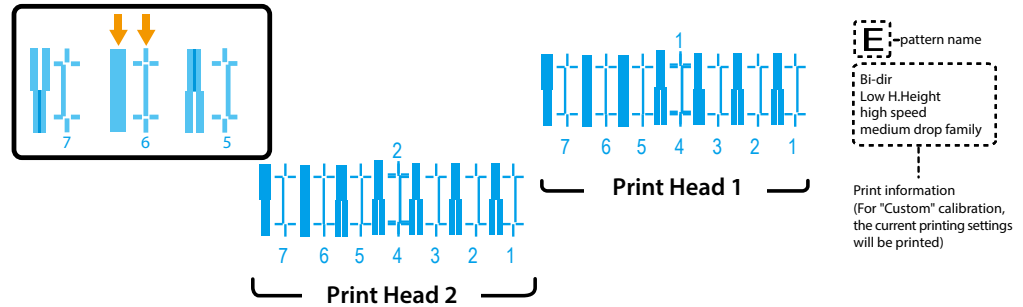

7 Enter the number you selected.

- For the illustration in step 6, you will enter [Pattern E1: 6].
- / key: change the number.
- [Enter] key : Confirm the change.
- If you have selected [Adjust Print3: Custom] > [Fine Pattern ALL], you will need to select and enter the number from each pattern A, B, D and E.

8 Follow the steps 6 & 7 to do calibration for Print Head 2.

Adjustment pattern for each print mode

print mode	pattern
High Quality	Pattern E
Quality	
Production	Pattern D
High Speed	
Draft	

Before Use

Printing workflow

Basic Operations

Powering ON / OFF

Various Settings

Loading a roll media into the printer

Maintenance

Nozzle check and cleaning

When problems occur

Calibrating your printer

Appendix

Start printing

Advanced settings

Operating from the printer control panel

Sleep Mode

Media feed adjustment

This adjustment corrects the media feed amount.

Make sure to run this adjustment when

- you use this product for the first time
- you changed to the different types of media
- you changed the pressure of pressure rollers

When the following symptom appears on your prints, you should run this adjustment:

- Images are overlapping.
- White lines appear in an image.

Other than above cases, move to ["Nozzle check and cleaning" P.61](#) .

Media feed adjustment steps







Note

- To print an adjustment pattern, more than 400 mm of printable area is required. If less than 400 mm, adjustment cannot be performed.
- Changing the origin setting for CR and the left and right side margins with reference to the width of media loaded can increase or decrease the width of printable area.



 ["Media Width" P.111](#) , ["Origin" P.112](#) , ["Side Margin" P.111](#)



1 Load a roll media.
 ["Loading a roll media into the printer" P.49](#)

2 Access the "PF Adjust" menu in the user type menu.

- Tap  [Home]key. [Setup] appears.
- Tap  key twice so that [User Type: Typee 1] appears.
- Use  /  key to select a user type.
- Tap  [Enter] key.
- Tap  key to display [PF Adjust].

Before Use	Printing workflow
Basic Operations	Powering ON / OFF
Various Settings	Loading a roll media into the printer
Maintenance	Nozzle check and cleaning
When problems occur	Calibrating your printer
Appendix	Start printing
	Advanced settings
	Operating from the printer control panel
	Sleep Mode



- 3** Tap  key so that [PF Adjust1 Auto] appears.
- Use  /  key to select the menu you want to run.

Sub menu	Details	
Auto	The color sensor reads the adjustment pattern and the printer runs automatic media feed adjustment.  "Run an automatic media feed adjustment" P.80	
Initial Print	Specify the media feeding length and print an initial adjustment pattern.	 "Run a media feed adjustment manually" P.81
Initial Change	Measure the adjustment pattern printed and enter the measured length.	
Confirm Print	Print a confirmation pattern to check the adjustment.	
Micro Print	Print an adjustment pattern for fine adjustment.	
Micro Change	Check the micro adjustment pattern and enter the best fine adjustment value.	

- 4** Follow this step to perform adjustment.
 **"Run an automatic media feed adjustment" P. 80**

Before Use	Printing workflow
Basic Operations	Powering ON / OFF
Various Settings	Loading a roll media into the printer
Maintenance	Nozzle check and cleaning
When problems occur	Calibrating your printer
Appendix	Start printing
	Advanced settings
	Operating from the printer control panel
	Sleep Mode

Run an automatic media feed adjustment

- 1 Select [Auto].
 - Tap  [Enter] key so that the printer runs automatic media feed adjustment.
- 2 Once the adjustment is finished, the message [AutoAdjust Succeeded/OK ->Enter] appears.
 - When the adjustment is failed, the message [AutoAdjust Failed/ OK -> Enter] appears.
 - Tap  [Enter] key to end the adjustment.
 - If print defects persist, perform media feed adjustment manually using adjustment pattern.
 ["Run a media feed adjustment manually" P.81](#)

Note

The value after the automatic media feed adjustment is automatically saved in Micro Change.

Before Use

Printing workflow

Basic Operations

Powering ON / OFF

Various Settings

Loading a roll media into the printer

Maintenance

Nozzle check and cleaning

When problems occur

Calibrating your printer

Appendix

Start printing

Advanced settings

Operating from the printer control panel

Sleep Mode

Run a media feed adjustment manually

- You will need a ruler for this adjustment.
- If you already know the adjustment value, move to step 9 to enter the value.

1 Perform an "Initial Print".

- Select [Initial Print] and tap  key.
- [FeedLength 250mm] appears. Use  /  key to enter the media feeding length.
- Tap  [Enter] key to print a pattern.

Note

By default, the feed length is set to 250 mm. Increasing feed length will slightly improve accuracy of media feed adjustment.

2 Cut it off the roll media (if needed).

3 Use a ruler to measure the distance between 「-」 marks printed.

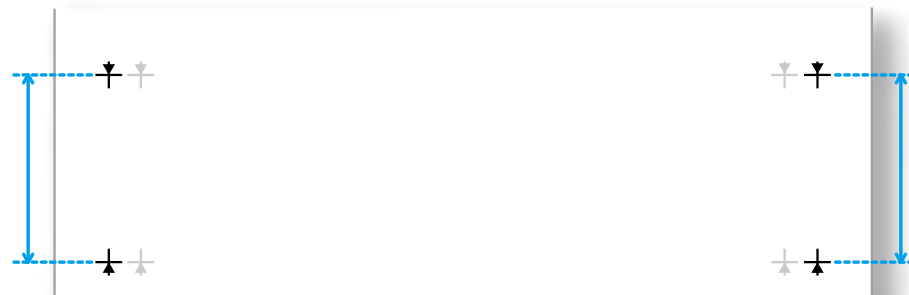

Note

The above pattern is an example of 6-color configuration. For 4-color configuration, only outer pattern (black marks) will be printed.

Before Use	Printing workflow
Basic Operations	Powering ON / OFF
Various Settings	Loading a roll media into the printer
Maintenance	Nozzle check and cleaning
When problems occur	Calibrating your printer
Appendix	Start printing
	Advanced settings
	Operating from the printer control panel
	Sleep Mode

4 Enter the measured length in Initial Change.

- Select [Initial Change] and tap key.
- Use / key to enter the length measured in step 2 and tap key.

5 Perform a "Confirm Print".

- Select [Confirm Print] and tap key.
- [FeedLength 250mm] appears. Use / key to enter the media feeding length.
- Tap [Enter] key to print an adjustment pattern.

Note

By default, the feed length is set to 250 mm. Increasing feed length will slightly improve accuracy of media feed adjustment.

6 Cut it off the roll media (if needed).

7 Use a ruler to measure the distance between 「」 marks printed.

- If the length being displayed and the measured distance match: move to the next step.
- If the length being displayed and the measured distance do not match: go back to step 1 and do the adjustment again.

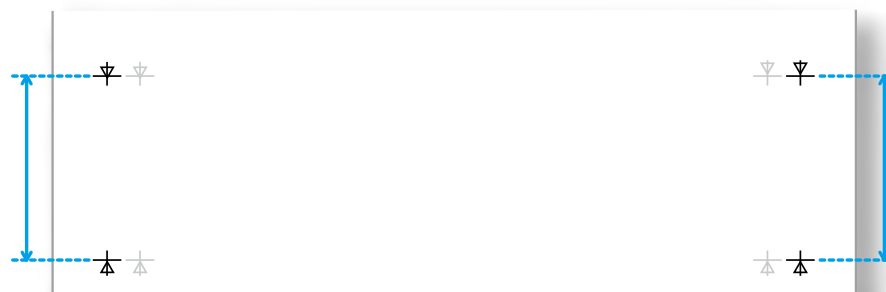

Note

The above pattern is an example of 6-color configuration. For 4-color configuration, only outer pattern (black marks) will be printed.

Before Use

Printing workflow

Basic Operations

Powering ON / OFF

Various Settings

Loading a roll media into the printer

Maintenance

Nozzle check and cleaning

When problems occur

Calibrating your printer

Appendix

Start printing

Advanced settings

Operating from the printer control panel



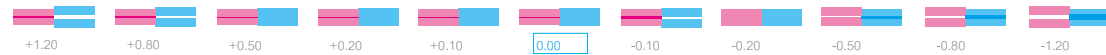
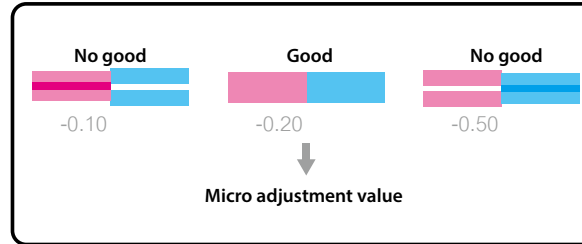

Sleep Mode

8 Perform a "Micro Print".

- Select [Micro Print].
- Tap  [Enter] key to print an adjustment pattern.
- Look at the print and select a pattern that has least white lines or overlapping. The value written under the selected pattern will be the micro adjustment value.



9 Enter the micro adjustment value selected.

- Select [Micro Change] and tap  key.
- [Micro (-5 - 5) 5.00%] will be displayed.
- Use  /  key to enter the micro adjustment value and then tap  [Enter] key.

Note

Once the micro adjustment value has been saved, the value will become the reference value to be printed in the center of the pattern from the next print.

For example, if you have entered "-0.20" and print a micro adjustment pattern, values printed below block pattern will be changed to (from left) +1.00, +0.60, +0.30, 0.00, -0.20 (reference value), -0.30, -0.40, -0.70, -1.00, -1.40.

Before Use

Printing workflow

Basic Operations

Powering ON / OFF

Various Settings

Loading a roll media into the printer

Maintenance

Nozzle check and cleaning

When problems occur

Calibrating your printer

Appendix

Start printing

Advanced settings

Operating from the printer control panel

Sleep Mode

Start printing

Here we will explain the basic printing procedure (a single layer printing) using VerteLith.

For more details of VerteLith setup and operation, see the VerteLith user manual.

Print an image

1 Start VerteLith. Select "XPJ-1682UR" from the list of printer (①)

- [XPJ-1682UR] will appear. (②)

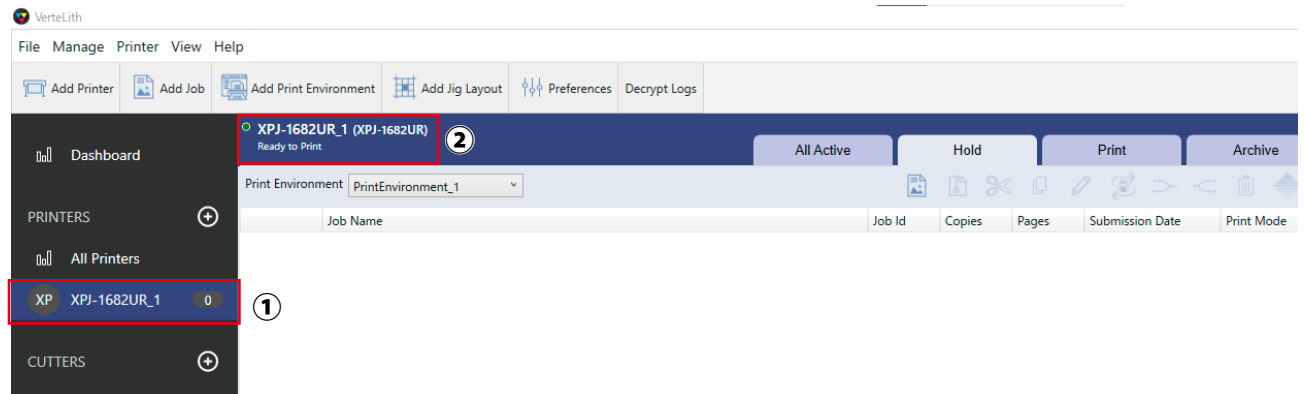

Note

For how to add a printer to VerteLith, see the VerteLith user manual.

Before Use

Printing workflow

Basic Operations

Powering ON / OFF

Various Settings

Loading a roll media into the printer

Maintenance

Nozzle check and cleaning

When problems occur

Calibrating your printer

Appendix

Start printing

Advanced settings

Operating from the printer control panel

Sleep Mode

2

Add an image file you want to print.

- In the Hold queue, click the [Add Job] icon (3) so that the open dialog appears.

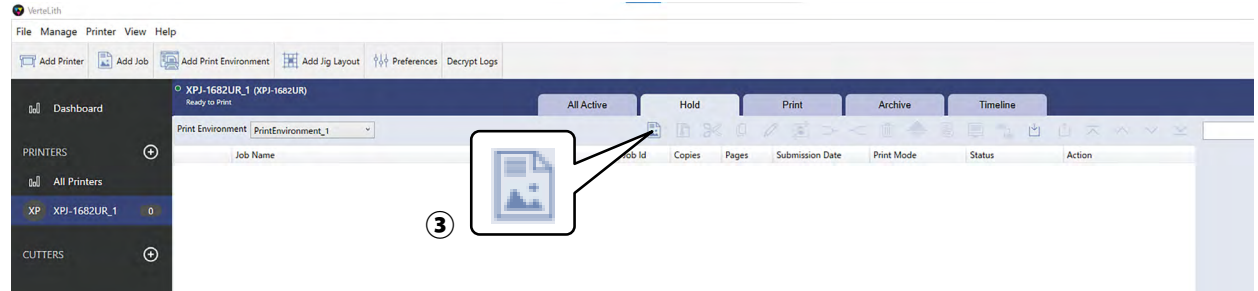

- Select an image file and click [OK] to add it to the Hold queue (4). You can add multiple files here.

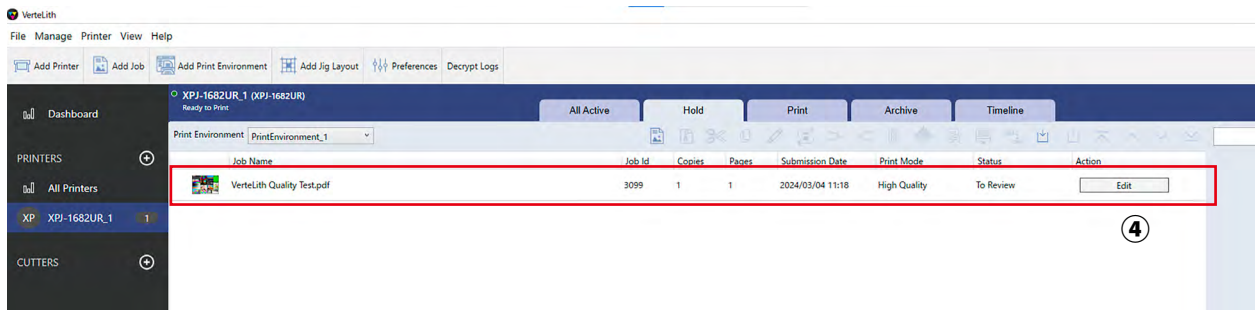

Note

You can also drag and drop files in the Hold queue.

Before Use

Printing workflow

Basic Operations

Powering ON / OFF

Various Settings

Loading a roll media into the printer

Maintenance

Nozzle check and cleaning

When problems occur

Calibrating your printer

Appendix

Start printing

Advanced settings

Operating from the printer control panel

Sleep Mode

3

Select a print job and click [Edit] (5) or [Edit Job] (6) .

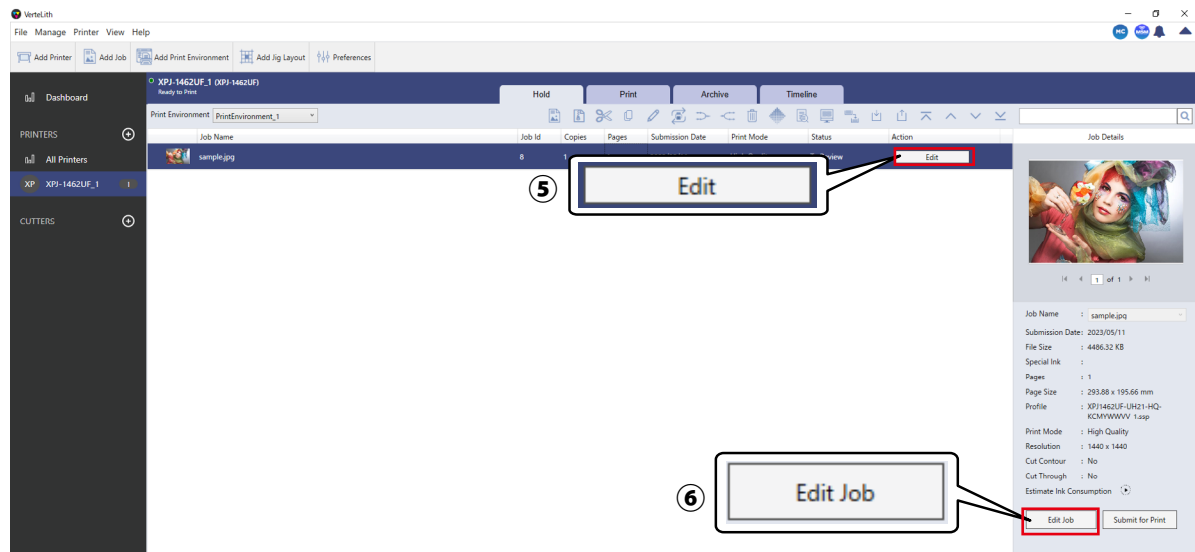

4

[Edit Job Settings] (7) appears. Click the Printer Profile tab (8) .

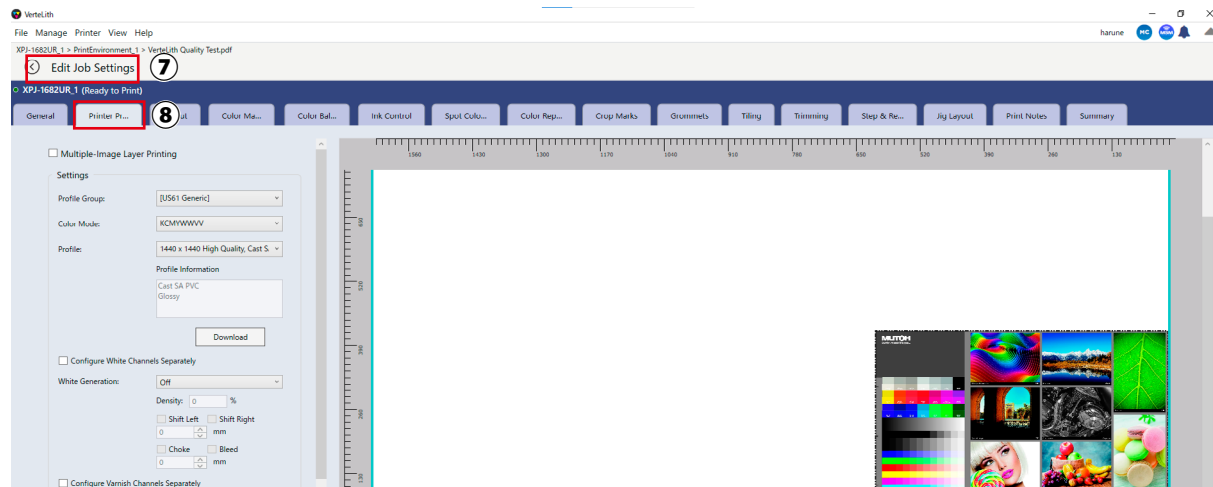

Before Use	Printing workflow
Basic Operations	Powering ON / OFF
Various Settings	Loading a roll media into the printer
Maintenance	Nozzle check and cleaning
When problems occur	Calibrating your printer
Appendix	Start printing
	Advanced settings
	Operating from the printer control panel
	Sleep Mode

5 Configure the basic print settings.

Profile Group option (9)

- Select an appropriate profile group depending on the ink being used.

Profile option (10)

- Select an appropriate profile depending on the media type and print mode.

Printer Options (11)

- Additional advanced settings can be configured (you can also print with default settings).

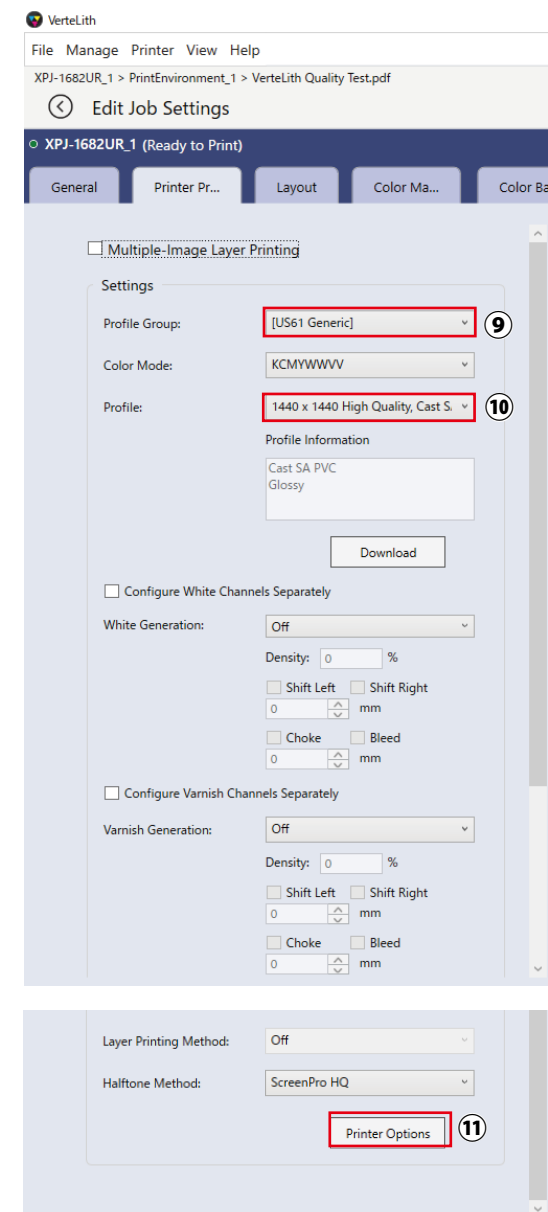

Before Use

Printing workflow

Basic Operations

Powering ON / OFF

Various Settings

Loading a roll media into the printer

Maintenance

Nozzle check and cleaning

When problems occur

Calibrating your printer

Appendix

Start printing

Advanced settings

Operating from the printer control panel

Sleep Mode

- 6 Once you have set the print settings, click [Submit for Print] (12) so that the job will move to the Print queue. Printing begins after RIP processing.

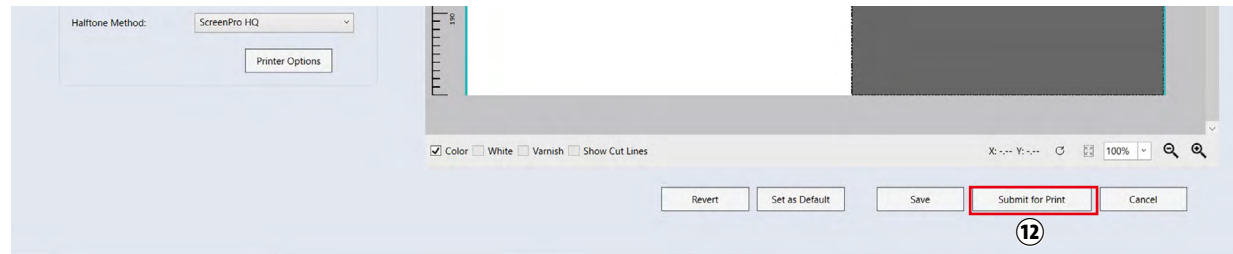

- The processing status of the job (Sending, Waiting for ripping, Ripping, Waiting for Print) can be viewed (13).

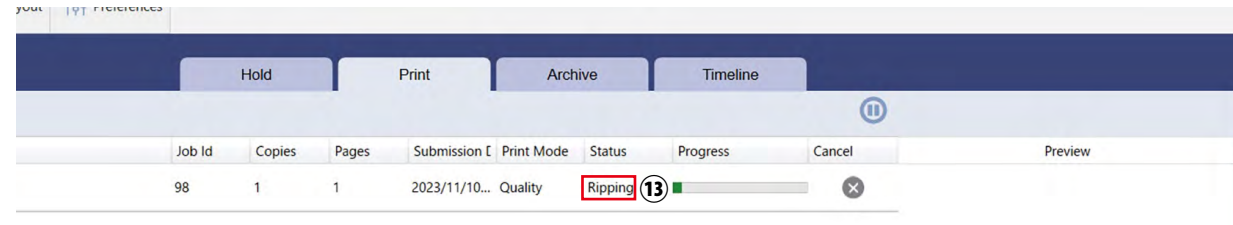

- The job will automatically move to the Hold queue after printing (14).

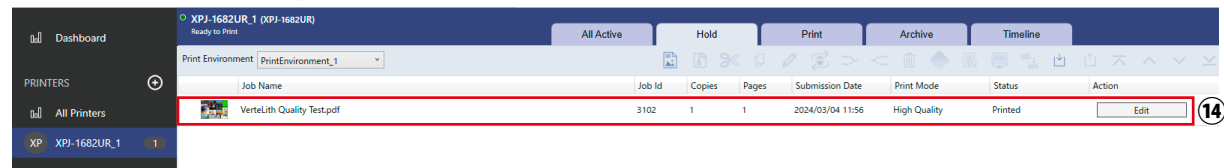

Before Use

Printing workflow

Basic Operations

Powering ON / OFF

Various Settings

Loading a roll media into the printer

Maintenance

Nozzle check and cleaning

When problems occur

Calibrating your printer

Appendix

Start printing

Advanced settings

Operating from the printer control panel

Sleep Mode

Pause / Resume / Cancel a print job

- 1 Clicking the [Pause Print] icon (①) will put the RIP processed job into “Waiting for Print” status (you cannot pause the job being sent).

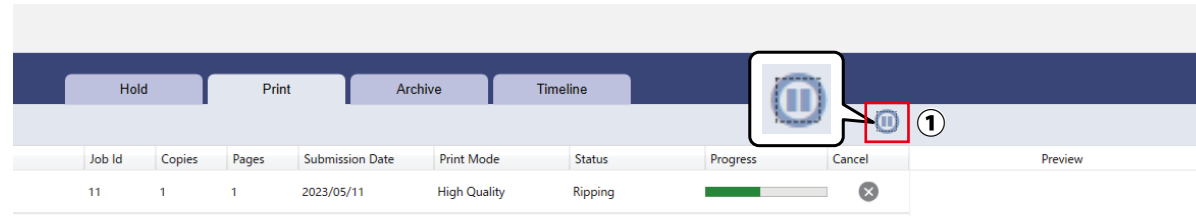

- 2 Clicking the [Resume Print] icon (②) will resume the print job which is in “Wait for Print” status.

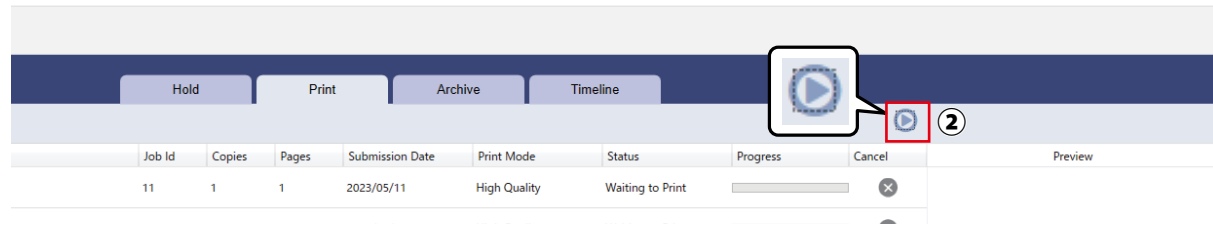

- 3 Clicking the [Cancel] icon (③) will cancel printing the job.

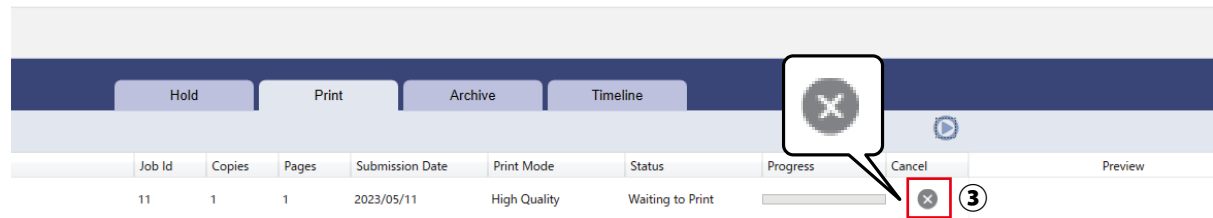

Before Use

Printing workflow

Basic Operations

Powering ON / OFF

Various Settings

Loading a roll media into the printer

Maintenance

Nozzle check and cleaning

When problems occur

Calibrating your printer

Appendix

Start printing

Advanced settings

Operating from the printer control panel

Sleep Mode

Advanced settings

Change your printer settings according to the type or condition of a roll media being loaded.

- If you get a head strike and ink smears on the media
☞ ["Printhead Height" P.91](#)
- To print on thin or soft media
☞ ["Changing holddown pressure using media feed lever" P.93](#)
☞ ["Canceling or reducing pressure rollers individually" P.94](#)

Note

When printing on thin or soft media, wrinkles can be prevented by turning down the vacuum fan.

- ☞ ["Vacuum Fan" P.110](#)

Before Use

Printing workflow

Basic Operations

Powering ON / OFF

Various Settings

Loading a roll media into the printer

Maintenance

Nozzle check and cleaning

When problems occur

Calibrating your printer

Appendix

Start printing

Advanced settings

Operating from the printer control panel

Sleep Mode

Printhead Height

Normally choose the "Low" or "Middle" head height option depending on the thickness of your media. The closer the gap between the media and the printhead, the better the consistency of the print quality.

Important !!

Depending on the condition of a roll media or media cockling caused by the printer settings, you may get a head strike causing ink smears on the media. In such cases, try followings:

- Reduce or cancel the pressure on the individual pressure rollers holding down the area where the cockling occurs.
 "Canceling or reducing pressure rollers individually" P.94
- After you change the head height, make sure to perform the print quality calibration.
- Do not open the front cover and change the head height during printing. Print quality cannot be guaranteed.

See the following table for the relationship between the head height and the recommended media thickness. Avoid using higher head height unless absolutely necessary, as the wider head gap will cause ink mist to adhere to the printhead nozzles, media or inside of the printer, adversely affecting print quality or leading to damage to the printer parts.

Head height	Recommended media thickness (1.0 mm or less)	Maximum media thickness that printer can feed	Description
Low	0.3 mm or below	0.3 mm	Normally use this head height.
Middle	0.3 mm to 0.8 mm	0.8 mm	Use this option for media between 0.3 mm to 0.8 mm thick or when the head strikes occur with Low setting.
High	0.8 mm to 1.3 mm	1.3 mm	Avoid using this option if a head strike does not occur with Middle setting. Because of wide distance between the print head and media, printing with "High" setting will generate ink mist, causing the following symptoms: <ul style="list-style-type: none">• Nozzle clogging• Ink smudges due to ink mist• Ink sticking inside of the printer

Before Use

Printing workflow

Basic Operations

Powering ON / OFF

Various Settings

Loading a roll media into the printer

Maintenance

Nozzle check and cleaning

When problems occur

Calibrating your printer

Appendix

Start printing

Advanced settings

Operating from the printer control panel

Sleep Mode

Changing the print head height

1 Open the front cover.

2 Use the head height adjustment lever (orange) to change the print head height.

head height	Description
High	The highest head height setting.
Middle	Use this option for media between 0.3 mm to 0.8 mm thick or when the head strikes occur with Low setting.
Low	Default head height. The lowest head height setting.

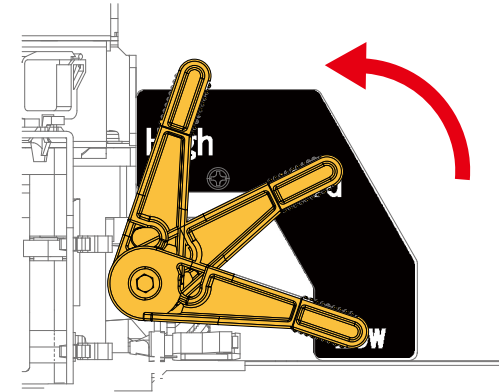

3 Close the front cover.

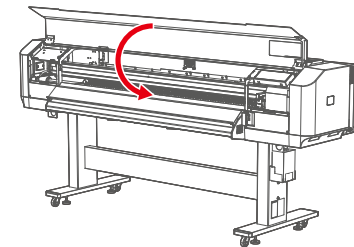

4 Perform print quality calibration.
👉 ["Print quality calibration \("Adjust Print"\)" P.72](#)

Before Use

Printing workflow

Basic Operations

Powering ON / OFF

Various Settings

Loading a roll media into the printer

Maintenance

Nozzle check and cleaning

When problems occur

Calibrating your printer

Appendix

Start printing

Advanced settings

Operating from the printer control panel

Sleep Mode

Changing holddown pressure using media feed lever

If you want to change the holddown pressure applied across the entire width of media, change it using the media feed lever.

Depending on the position of the lever, you can choose the pressure between Normal and High.

- Normal: Recommended for typical roll media. To apply normal pressure, push the lever from the front side of the printer until it clicks.
- High: Recommended for heavy weight media (such as Tarpaulin). To apply high pressure, push it as far as it goes.

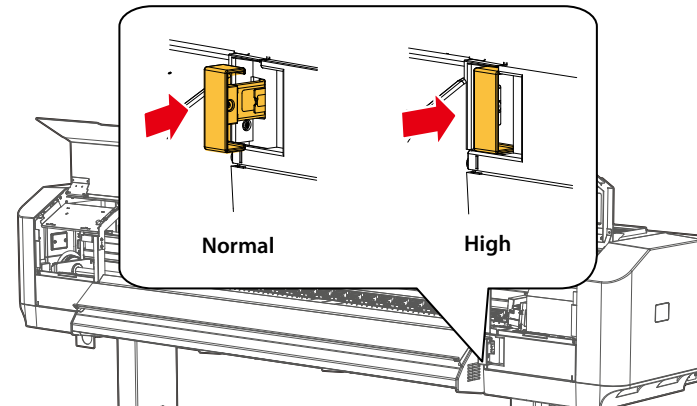

Important !!

Every time after you change the holddown pressure by the media feed lever, you must perform the media feed adjustment.

 "Media feed adjustment" P.78

Before Use	Printing workflow
Basic Operations	Powering ON / OFF
Various Settings	Loading a roll media into the printer
Maintenance	Nozzle check and cleaning
When problems occur	Calibrating your printer
Appendix	Start printing
	Advanced settings
	Operating from the printer control panel
	Sleep Mode

Canceling or reducing pressure rollers individually

When printing on thin or soft media, sometimes the media hits the print head causing ink smudge on the media. By reducing pressure or disabling the pressure rollers individually, it helps to reduce the chance of head strike. Using the slide lock lever on the individual pressure roller, the holddown pressure can be changed between Normal, Low and Cancel.

- Normal: Recommended for typical roll media. The factory default is set to Normal.
- Low: It reduces the holddown pressure.
- Cancel: It disables the pressure roller.

However, if the media feed lever is set to High, you can only choose between Normal and Cancel (even you set it to Low, the holddown pressure will not be reduced).

To cancel the individual pressure rollers, release the pressure rollers by fully pulling the media feed lever towards you as much as possible.

Media feed lever	Slide lock lever
Normal	Normal/ Low/ Cancel
High	Normal/ Cancel

Important !!

- Every time after you change the holddown pressure by individual slide lock lever, you must perform the media feed adjustment.

 ["Media feed adjustment" P.78](#)

Note

Thin or soft media is likely to cockle while printing. Wrinkles can contact the bottom side of the print head causing ink smudge on the media. Canceling the pressure rollers on both edges of media will help to prevent cockling.

Before Use

Printing workflow

Basic Operations

Powering ON / OFF

Various Settings

Loading a roll media into the printer

Maintenance

Nozzle check and cleaning

When problems occur

Calibrating your printer

Appendix

Start printing

Advanced settings

Operating from the printer control panel

Sleep Mode

Steps

1 Open the front cover.

2 Change the position of the media feed lever according to usage.

■ To cancel the individual pressure rollers

- From the front side of the printer, fully pull the media feed lever towards you to release the pressure rollers.

■ To set the slide lock lever to the Low position

- Set the media feed lever to the Normal position.

☞ **“Changing holddown pressure using media feed lever” P.93**

Note

You cannot cancel the individual pressure rollers unless you release the pressure rollers by the media feed lever.

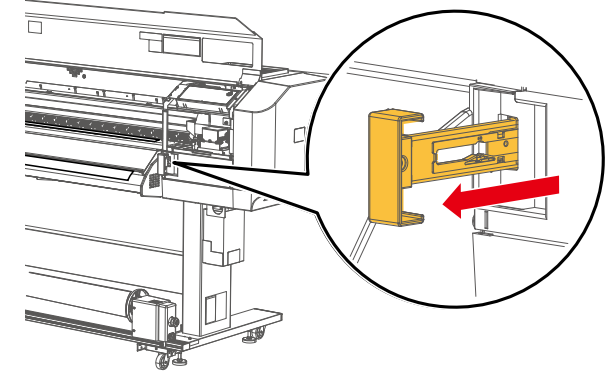

3 Push down the tab on the slider lock lever, then slide it to the front.

- To reduce pressure, slide it to front until it clicks.
- To cancel the pressure roller, fully slide it to the front until it clicks into place.

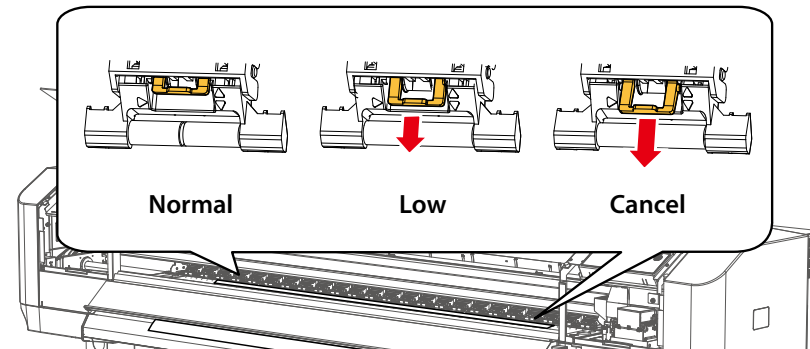

Before Use

Printing workflow

Basic Operations

Powering ON / OFF

Various Settings

Loading a roll media into the printer

Maintenance

Nozzle check and cleaning

When problems occur

Calibrating your printer

Appendix

Start printing

Advanced settings

Operating from the printer control panel

Sleep Mode

 Note

First, try to reduce or cancel the rollers on both edges of the media. If the problem persists, reduce or cancel more rollers.

- 4 (To cancel the individual pressure rollers) Push the media feed lever back to the original position to lock the pressure rollers.

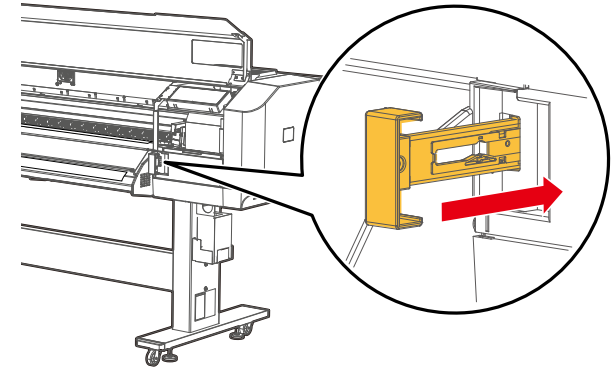

- 5 Close the front cover.

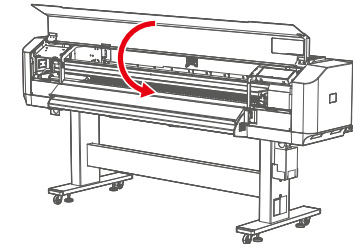

- 6 Perform media feed adjustment.
 ["Media feed adjustment" P.78](#)

Before Use

Printing workflow

Basic Operations

Powering ON / OFF

Various Settings

Loading a roll media into the printer

Maintenance

Nozzle check and cleaning

When problems occur

Calibrating your printer

Appendix

Start printing

Advanced settings

Operating from the printer control panel





Sleep Mode

Operating from the printer control panel

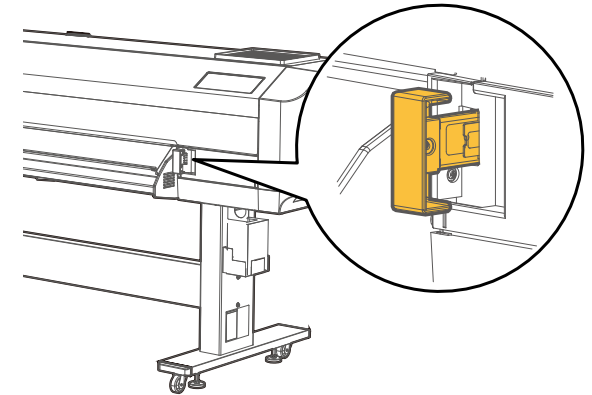
Feeding media

- 1 Check that the pressure rollers hold down the media.



- 2 Tap  or  to feed a roll media until it reaches to the desired position.
 -  key: Feed the media backward.
 -  key: Feed the media forward.

Note

Long tap the key to feed the media with high speed.

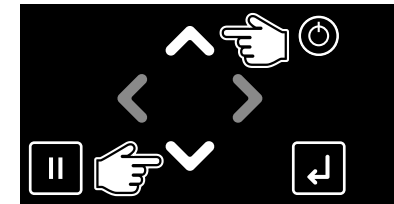

- 3 Once it has reached the intended position, release the key.

Before Use	Printing workflow
Basic Operations	Powering ON / OFF
Various Settings	Loading a roll media into the printer
Maintenance	Nozzle check and cleaning
When problems occur	Calibrating your printer
Appendix	Start printing
	Advanced settings
	Operating from the printer control panel
	Sleep Mode

Pausing / Resuming printing

1 Tap  [Cancel] key while printing.

- The printer will pause the job.



Note

- You cannot cancel the job by tapping  [Cancel] key.
- To cancel the job, see the following section.

 ["Canceling printing" P.99](#)

2 Tap  [Cancel] key again to resume printing.

Pausing Print
Cancel Print -> Enter

Important !!

MUTOH cannot guarantee the print quality when you resume the printing.

Before Use

Basic Operations

Various Settings

Maintenance

When problems occur

Appendix

Printing workflow

Powering ON / OFF

Loading a roll media into the printer

Nozzle check and cleaning

Calibrating your printer

Start printing

Advanced settings

Operating from the printer control panel

Sleep Mode

Canceling printing

- 1 Tap  [Cancel] key while printing.
 - The printer will pause printing.

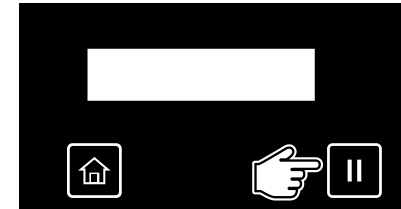

Note

To resume printing, tap  Cancel key again.

- 2 Tap  [Enter] key to cancel printing. (Once canceled, you cannot resume the job again.)

- The data sent to the printer will be deleted.

Pausing Print

Cancel Print

-> Enter

Note

You can also cancel the job from the remote panel on MSM.

Before Use

Printing workflow

Basic Operations

Powering ON / OFF

Various Settings

Loading a roll media into the printer

Maintenance

Nozzle check and cleaning

When problems occur

Calibrating your printer

Appendix

Start printing

Advanced settings

Operating from the printer control panel

Sleep Mode

Cutting media

1 Check that the job has been printed.

- Tap  [Cancel] key.



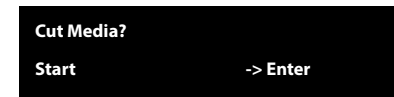

2 Tap  [Enter] key.

- The printer will advance the media for the bottom margin and will cut it off the roll media.



Note

- If the leading edge of a new roll media is not straight, cut it before printing.
- When Media Initial menu is set to "Off", the printer does not cut the media automatically.
 ["Media Initial" P.111](#)
- When the Output Mode menu is set to "Auto Cut", the printer cuts the media automatically after printing.
 ["Output Mode" P.111](#)
- The cutter blade is consumable parts. Replace it when needed.
 ["Replacing Cutter" P.204](#)

Before Use	Printing workflow
Basic Operations	Powering ON / OFF
Various Settings	Loading a roll media into the printer
Maintenance	Nozzle check and cleaning
When problems occur	Calibrating your printer
Appendix	Start printing
	Advanced settings
	Operating from the printer control panel
	Sleep Mode

Displaying the time until the next time ink agitation is required

- 1 While "Print Ready" or "Media End" appears, tap  [Enter] key.
- 2 The time until the next ink agitation is required is displayed.
For details, see ["Agitating ink from the direct key" P.150](#)

Before Use	Printing workflow
Basic Operations	Powering ON / OFF
Various Settings	Loading a roll media into the printer
Maintenance	Nozzle check and cleaning
When problems occur	Calibrating your printer
Appendix	Start printing
	Advanced settings
	Operating from the printer control panel
	Sleep Mode

Menus you can access while printing

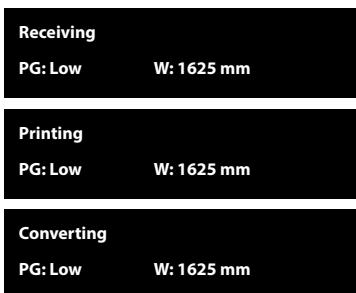

1. While one of these messages appears, tap [Home] key.
2. Use / key to select a menu.

Menu	Functions
PF Micro Adj.	<p>Correct the media feed amount. Use / key to change the settings. Tap [Enter] key to confirm the change.</p> <div style="border: 1px solid green; padding: 5px;"> <p> Note</p> <ul style="list-style-type: none"> • The change made becomes invalid after printing is complete. • You can also save this change in the selected user type. "Backup" P.102 </div>
Backup	<p>Save the change made in the "PF Micro Adj." menu to the selected user type. Use / key to select [Yes]. Tap [Enter] to confirm the change.</p>
Job status	<p>Displays information on a print job being printed. Use / key to select the item you want to view.</p> <ul style="list-style-type: none"> • ToDoLength : Displays the length of print data. • Done : Displays the length printed. • Remain : Displays the length of data which has not been printed yet. • Remain Time : Displays the time remaining to finish printing. <div style="border: 1px solid green; padding: 5px;"> <p> Note</p> <ul style="list-style-type: none"> • The value displayed is reference only, not guaranteed. • If print data does not contain length information, "0" will be displayed in all items. </div>
MPS	<p>Displays the MPS status (ON or OFF). The settings of MPS can be changed in MSM.</p>

Before Use	Printing workflow
Basic Operations	Powering ON / OFF
Various Settings	Loading a roll media into the printer
Maintenance	Nozzle check and cleaning
When problems occur	Calibrating your printer
Appendix	Start printing
	Advanced settings
	Operating from the printer control panel
	Sleep Mode

Sleep Mode

This product must be powered on all the time. While not in use, make sure to put it into sleep mode. Failure to do so may result in ink settling, causing print defects or printer failure.

When waking from sleep mode, the printer will perform automatic maintenance depending on the elapsed time.

Sleep mode flow



Before putting the printer into sleep mode, follow the instructions on the printer control panel to perform a daily maintenance. For detailed procedures, please refer to the following.

 [“Daily maintenance at the end of work” P.171](#)

Before Use	Printing workflow
Basic Operations	Powering ON / OFF
Various Settings	Loading a roll media into the printer
Maintenance	Nozzle check and cleaning
When problems occur	Calibrating your printer
Appendix	Start printing
	Advanced settings
	Operating from the printer control panel
	Sleep Mode

If you are going to leave the printer in sleep mode for a long period of time

If you are going to leave the printer in sleep mode for a long period of time, perform followings in advance.

- Check that the ink cartridges (ink bags) have sufficient ink.
 ["Checking ink level and replacing cartridge" P. 158](#)
- Empty the waste ink tank.
 ["Emptying waste ink tank" P. 167](#)

Important !!

During sleep mode, check the ink level in the ink cartridges (ink bags). When the message [Ink Low] appears on the control panel, replace with new ones.

 ["Checking ink level and replacing cartridge" P.158](#)

To wake up from sleep mode

- 1 To wake up from sleep mode, tap  [Enter] key.

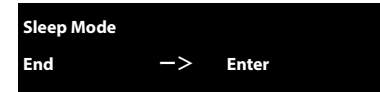

Note

When the printer wakes up from sleep mode, an appropriate automatic cleaning (head cleaning or "Little Charge") depending on the elapsed time.

Various Settings

Key operation	106
Print settings menu	108
Test Print menu	123
Maintenance menu	126
Printer Status menu	128
System Information menu	130
Roll Length Manage menu	131
Media Adjustment menu	135
Ink Agitation menu	137
Sleep Mode menu	141

Before Use

Basic Operations

Various Settings

Maintenance

When problems occur

Appendix

Key operation

Print settings menu

Test Print menu

Maintenance menu

Printer Status menu

System Information menu

Roll Length Manage menu

Media Adjustment menu

Ink Agitation menu

Sleep Mode menu

Key operation



You will configure the printer settings in the printer control panel.

- 1 To access the panel setup menu, tap  [Home] key..





Note

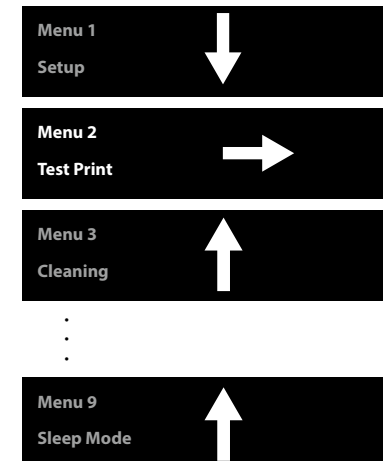

You cannot access to the panel setup menu while printing or receiving data (the power button is flashing).

- 2 Use  or  to scroll through the menu.
 - Use  to go to the menu.



Before Use	Key operation
Basic Operations	Print settings menu
Various Settings	Test Print menu
Maintenance	Maintenance menu
When problems occur	Printer Status menu
Appendix	System Information menu
	Roll Length Manage menu
	Media Adjustment menu
	Ink Agitation menu
	Sleep Mode menu

3 Use  or  to choose the option from the sub menu or enter the value.

- To confirm the setting or run the selected function, tap  (Enter) key.
- Use  to return to the upper level menu. (In the example on the right, the display will return to "Menu2: Test Print".)

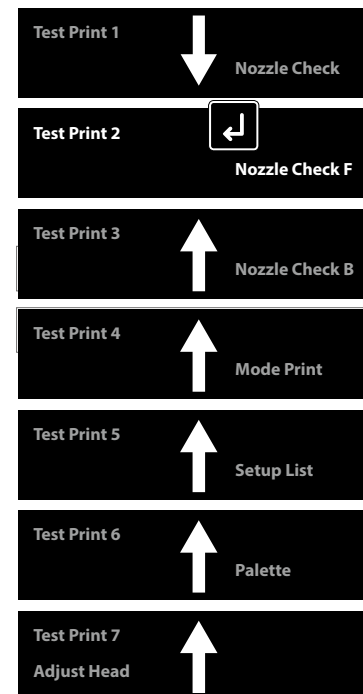

Before Use	Key operation
Basic Operations	Print settings menu
Various Settings	Test Print menu
Maintenance	Maintenance menu
When problems occur	Printer Status menu
Appendix	System Information menu
	Roll Length Manage menu
	Media Adjustment menu
	Ink Agitation menu
	Sleep Mode menu

Print settings menu

*Setting range : Underline indicates the default setting.

Settings menu	Setting range	Functions
User Type	<u>Type1</u> to Type15	<p>Create your own media preset for each media type (we call it "User Type") and save it with appropriate printer settings as "Type xx". You can define up to 15 user types.</p> <div style="border: 1px solid green; padding: 5px;"> <p>Important !!</p> <p>Selecting a different user type will switch all the settings in the printer that can be changed in the user type setting. The following settings can be changed in the user type setting:</p> <ul style="list-style-type: none"> • Print Mode, Effect, adjustment values of Adjust Print and PF Adjust • Vacuum fan, Thickness <p>When using the printer for the first time or using a different type of media, specify the settings of each item in User Type.</p> </div>
Print Mode	High Quality, <u>Quality</u> , Production, High Speed, Draft	<p>Select the print mode from the options.</p> <ul style="list-style-type: none"> • High Quality: Select this to deliver higher quality printing. • Quality: Select this for quality printing. • Production: Select this to print with standard quality and speed. • High Speed: Select this for high-speed printing. • Draft: Select this to print at faster than High speed mode.
Effect	None, <u>i-Weave UVEx</u>	An appropriate effect option is selected automatically.

Before Use	Key operation
Basic Operations	Print settings menu
Various Settings	Test Print menu
Maintenance	Maintenance menu
When problems occur	Printer Status menu
Appendix	System Information menu
	Roll Length Manage menu
	Media Adjustment menu
	Ink Agitation menu
	Sleep Mode menu

Settings menu	Setting range	Functions
Adjust Print  "Print quality calibration ("Adjust Print")" P.72		Perform bidirectional printing calibration to align dot placement position. You will enter the thickness of media before calibration.
Auto	ALL, Standard, Adjust Pattern A , B, D, E	Run an automatic print quality calibration (Adjust Print) by reading the adjustment pattern using the color sensor. <ul style="list-style-type: none"> • ALL: Automatically runs calibration of all adjustment patterns. • Standard: Automatically runs the same calibration as [Standard]. • Adjust Pattern A,B,D,E: Automatically runs calibration of an adjustment pattern selected from A, B, D or E.
Standard	Confirm Pattern, Rough Pattern, Fine Pattern	Calibrate dot placement position in bidirectional printing for the print mode specified in the selected user type. <ul style="list-style-type: none"> • Confirm Pattern: Print a test pattern for print quality calibration. • Rough Pattern: Perform this when the misalignment is large. Print an adjustment pattern and enter an adjustment value. • Fine Pattern: Perform this when the misalignment is small. Print an adjustment pattern and enter an adjustment value.
Custom	Confirm Pattern, Rough Pattern ALL, Rough Pattern A , B, D, E, Fine Pattern ALL, Fine Pattern A , B, D, E	Calibrate dot placement position in bidirectional printing for all print modes. <ul style="list-style-type: none"> • Confirm Pattern: Print a test pattern for print quality calibration. • Rough Pattern ALL: Print all the rough adjustment patterns and enter an adjustment value for each pattern. • Rough Pattern A,B,D,E: Print an adjustment pattern selected from A, B, D or E and enter the adjustment value. • Fine Pattern ALL: Print all the fine adjustment patterns and enter an adjustment value for each pattern. • Fine Pattern A,B,D,E: Print a fine adjustment pattern selected from A, B, D or E and enter the adjustment value.

Before Use	Key operation
Basic Operations	Print settings menu
Various Settings	Test Print menu
Maintenance	Maintenance menu
When problems occur	Printer Status menu
Appendix	System Information menu
	Roll Length Manage menu
	Media Adjustment menu
	Ink Agitation menu
	Sleep Mode menu

Settings menu	Setting range	Functions
PF Adjust ☞ "Media feed adjustment" P.78		Correct the media feed amount.
Auto		Run an automatic media feed adjustment by reading the adjustment pattern using the color sensor.
Initial Print	100mm to <u>250mm</u> to 500mm	Print an adjustment pattern with specified length.
Initial Change	Initial adjustment to correct paper feeding $\pm 50.0\text{mm}$	Measure the printed pattern and enter the measured length.
Confirm Print	100mm to <u>250mm</u> to 500mm	Print a confirmation pattern to check for adjustment.
Micro Print	Print 11 patterns with 0%, $\pm 0.1\%$, $\pm 0.2\%$, $\pm 0.5\%$, $\pm 0.8\%$, $\pm 1.2\%$	Print a micro adjustment pattern.
Micro Change	- 5.00% to <u>0.00%</u> to 5.00%	Check the printed micro adjustment pattern and enter a micro adjustment value written under the best pattern.
Vacuum Fan	Off, Low, Medium, High, Ex High	Select the suction power level.
Thickness	40um to 170um to 1300um	Enter the thickness of media being loaded.
Copy User Type	Type1 to Type15, ALL	The following settings of the selected user type can be copied to another user type: Print Mode/ Effect/ Adjustment value of Adjust Print/ PF Adjust / Vacuum fan / Thickness. When [ALL] is selected, these settings will be copied to all user types.
Initialization		Reset the settings of the selected user type.

Before Use	Key operation
Basic Operations	Print settings menu
Various Settings	Test Print menu
Maintenance	Maintenance menu
When problems occur	Printer Status menu
Appendix	System Information menu
	Roll Length Manage menu
	Media Adjustment menu
	Ink Agitation menu
	Sleep Mode menu

Settings menu	Setting range	Functions
Advanced Setting		
Side Margin	<u>5mm</u> to 80mm	Specify the left and right margins (side margin). <div style="border: 1px solid green; padding: 5px;"> <p>Important !!</p> <p>By default, the printer leaves 5 mm margin at right and print an image. If media skewed, you will get ink smudge on the media that is held down by the edge holder. In such cases, the side margin should be set to more than 10 mm.</p> </div>
Media Initial	Off, <u>Top&Width</u> , <u>Width</u>	Select how the printer detects the width of media. <ul style="list-style-type: none"> Off: No detection is performed. Top & Width: Automatically detects the width and the leading edge of media. Width: Automatically detects the width of media. <div style="border: 1px solid green; padding: 5px;"> <p>Note</p> <p>When the Media Initial menu is set to [Off], enter the width of media being loaded in the Media Width menu.</p> </div>
Media Width	210mm to <u>1000mm</u> to 1625mm	Enter the width of media being loaded. If the Media Initial menu is set to [Width] or [Top & Width], the media width that the printer automatically detected will be displayed.
Output Mode	<u>Off</u> , Take Up , Auto Cut	Select the how the printed media is processed. <ul style="list-style-type: none"> Off: Select this when you do not use the take-up unit. Take Up: Select this when you use the take-up unit. Auto Cut: Automatically cuts the printed media off the roll media. <p> "Method of Cut" P.114</p>

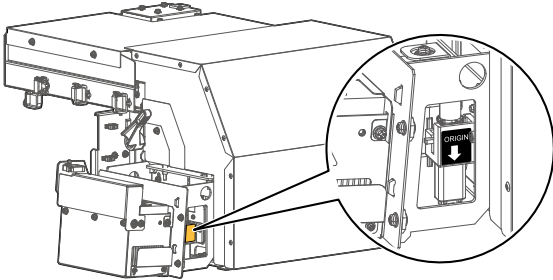

Before Use	Key operation
Basic Operations	Print settings menu
Various Settings	Test Print menu
Maintenance	Maintenance menu
When problems occur	Printer Status menu
Appendix	System Information menu
	Roll Length Manage menu
	Media Adjustment menu
	Ink Agitation menu
	Sleep Mode menu

Settings menu	Setting range	Functions
Origin	PF,CR	<p>Specify the print start position (origin) of print data.</p> <ul style="list-style-type: none"> ▲/▼ key: Change the print start position (origin) in the media feeding direction (PF). ◀/▶ key: Change the print start position (origin) in the print head moving direction (CR).  <p>The arrow mark on the Origin label shows the current print start position in CR direction.</p> <div style="border: 1px solid green; padding: 5px;"> <p>Note</p> <p>The setting range in the print head moving direction (CR) varies depending on the width of media. The maximum setting range is calculated as follows:</p> <p>Width of media - Side margins (left and right) - Minimum print area (210mm)</p> <p>☞ "Side Margin" P.111</p> <p>When the Output Mode menu is set to [Take Up], the setting range in the media feeding direction (PF) will be 0 mm to 15000 mm.</p> </div>
Start Feed	-10mm to 0mm to 500.0mm	<p>Specify the margin between pages.</p> <ul style="list-style-type: none"> Over 0 : Margin will increase than when set to 0. 0 : Margin between pages will not change. Blow 0 : Margin will decrease than when set to 0. <div style="border: 1px solid green; padding: 5px;"> <p>Note</p> <p>When the Output Mode menu is set to [Off], the margin between pages will be the length specified in the Start Feed menu plus 10 mm.</p> </div>

Before Use	Key operation
Basic Operations	Print settings menu
Various Settings	Test Print menu
Maintenance	Maintenance menu
When problems occur	Printer Status menu
Appendix	System Information menu
	Roll Length Manage menu
	Media Adjustment menu
	Ink Agitation menu
	Sleep Mode menu

Settings menu	Setting range	Functions
Front Interlace	<u>Auto</u> , Off	Automatically fine tunes the media feed amount to improve print quality of the first print swath. Normally this option should be set to [Auto]. In the following cases, selecting [Off] may improve print quality. <ul style="list-style-type: none"> Image quality of the first print swath is poor due to nozzle clogging. When printed with the Auto setting, image quality between the first print swath and the rest of the print are different.
Multi Strike	<u>1cnt</u> to 9cnt	Specify the number of times the printer prints the same line. Increase the number of times if you want to perform high density printing on transparent media. * For 6-color configuration printer, when this option is set to [1cnt], the Layer Multi Strike setting can be specified.
Layer Multi Strike (Color Layer)	<u>1cnt</u> to 9cnt	Specify this if you want to increase the number of times the printer prints the color (CMYK) layer.
Layer Multi Strike (White Layer)	<u>1cnt</u> to 9cnt	Specify this if you want to increase the number of times the printer prints the white layer.
Layer Multi Strike (Varnish Layer)	<u>1cnt</u> to 9cnt	Specify this if you want to increase the number of times the printer prints the varnish layer.
Pass Wait	<u>0.0s</u> to 5.0s	Specify the waiting time between passes. The next pass will be printed after the specified time given.
Head Travel	<u>Data</u> , Machine , <u>Media</u>	Select the width that the print head travels for printing from the following options: <ul style="list-style-type: none"> Data: travels the data width. Machine: travels the full printer width. Media: travels the media width.

Before Use	Key operation
Basic Operations	Print settings menu
Various Settings	Test Print menu
Maintenance	Maintenance menu
When problems occur	Printer Status menu
Appendix	System Information menu
	Roll Length Manage menu
	Media Adjustment menu
	Ink Agitation menu
	Sleep Mode menu

Settings menu	Setting range	Functions
Method of Cut	Single Cut – 2 steps , Single Cut – 3 steps , Double Cut – 2 steps , Double Cut – 3 steps	<p>Select the cutting method of media after printing.</p> <ul style="list-style-type: none"> Single Cut - 2 steps : Cut with less process than "Single Cut - 3 steps." This option is suitable for narrow-width media. Single Cut - 3 steps : Normal cutting method. Double Cut - 2 steps : Select this when "Single Cut - 2 steps" cannot fully cut the media. Double Cut - 3 steps : Select this when "Single Cut - 3 steps" cannot fully cut the media. <div style="border: 1px solid green; padding: 5px;"> <p> Note</p> <ul style="list-style-type: none"> Media cutting cannot be performed when the Media Initial menu is set to [Off].  "Media Initial" P.111 This option may not cut off some types of media. In such cases, set the Output Mode menu to [Off] and cut it manually.  "Output Mode" P.111 </div>
Cut Pressure	Low , <u>H</u> igh	<p>Select the pressure to cut media.</p> <ul style="list-style-type: none"> Low: Cut with less pressure than normal. Select this mode, when the High mode gives too much pressure or when you are using thin media. High: Normal cutting pressure.
Slant Check	Off , <u>O</u> n	When set to [On], the printer checks skew while feeding media.



Before Use	Key operation
Basic Operations	Print settings menu
Various Settings	Test Print menu
Maintenance	Maintenance menu
When problems occur	Printer Status menu
Appendix	System Information menu
	Roll Length Manage menu
	Media Adjustment menu
	Ink Agitation menu
	Sleep Mode menu

Settings menu	Setting range	Functions						
Spitting	Off, <u>On</u>	<p>Enable or disable the ink flushing maintenance.</p> <ul style="list-style-type: none"> On: Select this to perform an ink flushing on the flushing box. Normally, the Pass Count menu should be set to [1]. MUTOH cannot guarantee print quality if it is set to more than [1]. Off: Printer does not perform an ink flushing maintenance. With this setting, nozzle clogs easily. Normally, do not select [Off]. <p>Note</p> <p>Flushing is the print head maintenance to avoid nozzle clogging. It consumes some ink.</p>						
Pass Count	<u>1</u> to 999cnt	<p>Specify the interval to perform flushing on the flushing box. This option does not appear when the Spitting menu is set to [Off].</p> <p>Note</p> <p>Example of flushing operation</p> <table border="1"> <thead> <tr> <th>Pass Count</th> <th>When to perform flushing</th> </tr> </thead> <tbody> <tr> <td>1 count</td> <td>Printer performs flushing on the flushing box each time the print head travels back and forth.</td> </tr> <tr> <td>5 count</td> <td>Printer performs flushing on the flushing box once the print head travels back and forth five times.</td> </tr> </tbody> </table>	Pass Count	When to perform flushing	1 count	Printer performs flushing on the flushing box each time the print head travels back and forth.	5 count	Printer performs flushing on the flushing box once the print head travels back and forth five times.
Pass Count	When to perform flushing							
1 count	Printer performs flushing on the flushing box each time the print head travels back and forth.							
5 count	Printer performs flushing on the flushing box once the print head travels back and forth five times.							
Auto Cleaning		<p>Specify the automatic cleaning to be performed before printing or per total printing times.</p> <p>Note</p> <p>When printing is carried out while the ink agitation message appears, an automatic cleaning set in the Before Print menu and the Accumulated Print Time menu will not be performed. This is to avoid poor print results by using settled ink.</p>						
Before Print								
Cleaning Type	<u>Off</u> , Short, Normal, Long	Select the type of automatic cleaning to be performed before printing.						
Accumulation Print Time	<u>Off</u> , 1hour, 2hour, 3hour, 4hour	Specify the total print time that the printer performs automatic cleaning cycle. The type of cleaning is [Long] (unchangeable).						

Before Use	Key operation
Basic Operations	Print settings menu
Various Settings	Test Print menu
Maintenance	Maintenance menu
When problems occur	Printer Status menu
Appendix	System Information menu
	Roll Length Manage menu
	Media Adjustment menu
	Ink Agitation menu
	Sleep Mode menu

Settings menu	Setting range	Functions
White Maintenance *Displays on 6-color configuration only	<u>Little</u> , <u>Normal</u>	Select the white ink maintenance mode. <ul style="list-style-type: none"> If you barely use white ink for usual printing, selecting [Little] will reduce the amount of white ink consumption while the printer is in print ready state. <div style="border: 1px solid green; padding: 5px;"> <p>Note</p> <p>White ink has tendency to settle in the print head or ink lines. To prevent this, the printer spits out small amount of white ink periodically even while in print ready state.</p> </div>
Color Maintenance	<u>Off</u> , <u>Little</u> , <u>Normal</u>	When the printer has not been used for a certain period of time from the last use, an automatic color ink maintenance which spits out some ink is performed in order to ensure its performance. <ul style="list-style-type: none"> Off: Default setting Little: If you barely use white ink for usual printing, selecting this mode will reduce the amount of white ink consumption while in print ready state. Normal: Provides powerful maintenance than [Normal] to ensure color consistency. Select this when color inconsistency on a print is noticeable.
Head Select		Select a print head to use for printing. Printing speed will be slower, but you can continue printing even when the defect occurs on either one of the print head.
Single Head	<u>Off</u> , <u>Head1</u> , <u>Head2</u>	Select a print head to use for printing. <div style="border: 1px solid green; padding: 5px;"> <p>Note</p> <p>When you change the Single Head setting, the Nozzle Area Select setting in the Select Nozzle menu will automatically be set to [Nozzle All].</p> </div>
Select Nozzle  "Select Nozzle" P.119		If nozzle clogging still persists after several attempts of cleaning, you can choose only active nozzles for printing.
Print		Print a confirmation patterns.
Nozzle Area Select	<u>Nozzle All</u> , <u>Nozzle A ,B ,C ,D ,E ,F</u>	Select the nozzle area to use for printing.

Before Use	Key operation
Basic Operations	Print settings menu
Various Settings	Test Print menu
Maintenance	Maintenance menu
When problems occur	Printer Status menu
Appendix	System Information menu
	Roll Length Manage menu
	Media Adjustment menu
	Ink Agitation menu
	Sleep Mode menu

Settings menu	Setting range	Functions
Auto Nozzle Check  "Automatic nozzle checking (when optional drop sensor is installed)" P.121	On , Off	Select whether to run automatic nozzle check. In ON setting, the printer will check the nozzle conditions using the drop sensor and will automatically perform cleaning if nozzle clogs were detected. The printer runs an automatic nozzle check when: <ul style="list-style-type: none"> • powered on • waking up from sleep mode • performing the first print after the [Number of print job] setting was specified and each time before printing the specified number of print jobs. If nozzle clogging still persists after three cleaning attempts, the printer will automatically select a nozzle segment that works properly to continue printing.
<div style="border: 1px solid green; padding: 5px;"> <p> Note</p> <p>This menu is not displayed when the optional drop sensor is not installed.</p> </div>		
Number of print jobs	Off to 1 count to 30 count (increments of 1)	You can specify the automatic nozzle check cycle by the number of print jobs performed. When specified, the printer will run an automatic nozzle check in the following timing: <ul style="list-style-type: none"> • Before the first printing after this setting was specified. • Each time before printing the specified number of jobs.
Select Nozzle	On , Off	In the ON setting, if there is no missing lines in the nozzle check print even after three cleanings, the printer will automatically select one nozzle segment that works properly to continue printing.
Header Dump	Off , On , Dump , Print	Select whether to print the following dump information for the print data; data header/ the number of ink drops jetted for print data (data dot number)/ printer serial number/ firmware version. <ul style="list-style-type: none"> • Off: This information will not be printed. • On: The printer prints an image data followed by dump information. • Dump: The printer prints dump information except data dot number. • Print: The printer prints the last dump information. The message [No data] will appear if there is no dump information in the history. <div style="border: 1px solid green; padding: 5px; margin-top: 10px;"> <p> Note</p> <p>.Dump data is used for reference information when you receive technical support.</p> <p>.When you are printing through computer, the print settings configured in the RIP software will be printed here.</p> </div>

Before Use	Key operation
Basic Operations	Print settings menu
Various Settings	Test Print menu
Maintenance	Maintenance menu
When problems occur	Printer Status menu
Appendix	System Information menu
	Roll Length Manage menu
	Media Adjustment menu
	Ink Agitation menu
	Sleep Mode menu

Settings menu	Setting range	Functions
Init. Settings		Select printer settings.
Language	<u>English</u> , Dutch, Spanish, French, Italian, Portuguese, German, Japanese	Select the language on the printer control panel.
Length	<u>mm</u> , inch	Select the unit of length to be used on the display of the printer control panel.
Remain Ink	Off, <u>On</u>	Select the way to indicate ink levels. <ul style="list-style-type: none"> On: Displays the ink level indicator. Off: Displays the ink slot number that an error occurs (e.g. ink end, ink low, no ink cartridge (ink bag)).  “Ink level indicator on the printer control panel” P.31
IP Address	0.0.0.0 to <u>192.168.1.253</u> to 255.255.255.255	
Subnet Mask	0.0.0.0 to <u>255.255.255.0</u> to 255.255.255.255	
Gateway	0.0.0.0 to <u>192.168.1.254</u> to 255.255.255.255	
AlertBuzzer	Off, <u>On</u>	Select how the alert buzzer beeps: <ul style="list-style-type: none"> On: The buzzer beeps continuously. Off: The buzzer beeps only once.
Initialization		Restore the settings of this printer to the factory defaults.
User All		Reset all the user types.
Advanced Settings		Reset all the settings in [Advanced Settings].
Init. Settings		Reset all the settings in [Initial Settings].
ALL		Reset all the settings in [User Type], [Advanced Settings], [Initial Settings].

Before Use

Basic Operations

Various Settings

Maintenance

When problems occur

Appendix

Key operation

Print settings menu

Test Print menu

Maintenance menu

Printer Status menu

System Information menu

Roll Length Manage menu

Media Adjustment menu

Ink Agitation menu

Sleep Mode menu

Select Nozzle

If nozzle clogging still persists after several attempts of cleaning, you can choose only active nozzles for printing.



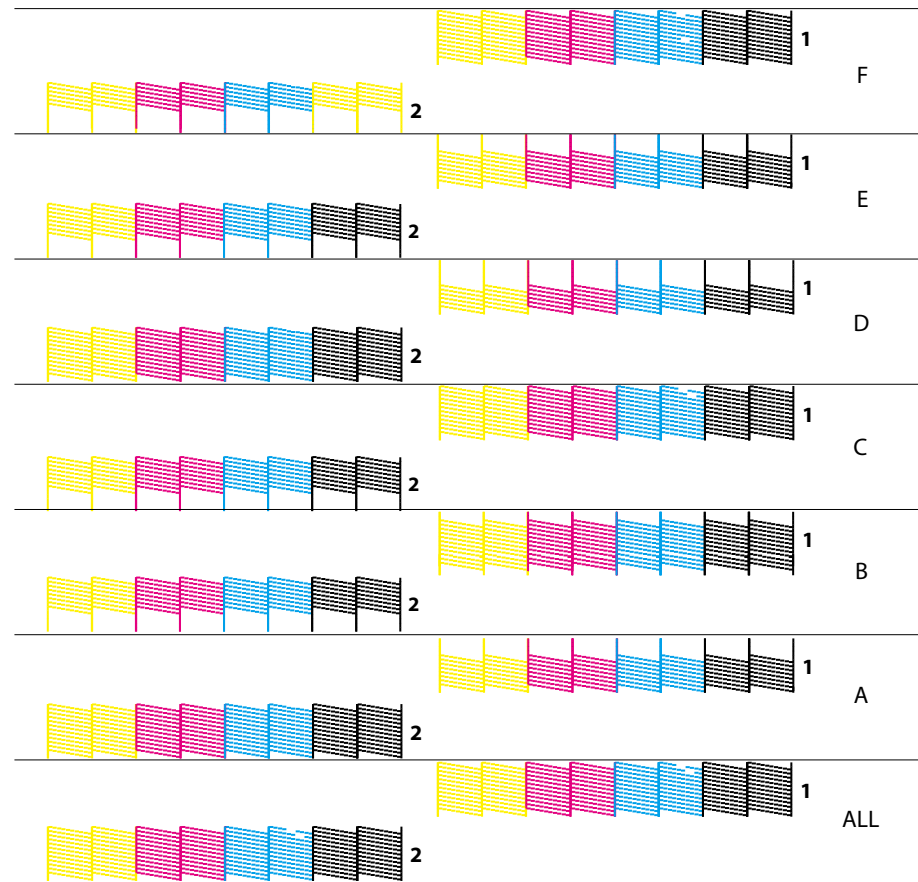

1 Print a confirmation pattern and select the pattern that has no missing lines.

1. Select [Print].
2. Tap  key to print a confirmation pattern.
3. Look at the patterns and select the pattern that has not missing lines.
 - In the example of illustration below, the patterns A, B, D and E do not have nozzle clogging. (This illustration is the pattern for 4-color configuration)



Before Use	Key operation
Basic Operations	Print settings menu
Various Settings	Test Print menu
Maintenance	Maintenance menu
When problems occur	Printer Status menu
Appendix	System Information menu
	Roll Length Manage menu
	Media Adjustment menu
	Ink Agitation menu
	Sleep Mode menu

2 Select the pattern that does not have nozzle clogging.

1. [Select [Nozzle Area Select].
2. Tap  key.
3. Use  /  key to select the pattern that does not have nozzle clogging.
4. Tap  [Enter] key.

 **Note**

If there are more than one pattern that do not suffer from nozzle clogging, select the one that has more number of active nozzles.

In descending order of active nozzles: ALL > A = B = C > D = E = F. If the patterns A and D had no missing lines, you should select the pattern A.

Before Use	Key operation
Basic Operations	Print settings menu
Various Settings	Test Print menu
Maintenance	Maintenance menu
When problems occur	Printer Status menu
Appendix	System Information menu
	Roll Length Manage menu
	Media Adjustment menu
	Ink Agitation menu
	Sleep Mode menu

Automatic nozzle checking (when optional drop sensor is installed)

This function is available when the optional drop sensor is installed in the printer.
For details of drop sensor, see "Drop Sensor Operation Manual".

Important !!

In case the printer is used in the non-recommended environment or depending on the ink being used, the following phenomenon may appear:

- The printer performs cleaning cycle each time an automatic nozzle check is run.
- Automatic nozzle checking takes more time.
- Even if an automatic nozzle checking was performed, nozzle clogging appears on the print. (*)

*If nozzle clogging persists, manually run a nozzle check and cleaning.
 ["Nozzle check and cleaning" P.61](#)

This function does not guarantee 100 percent prevention of nozzle clogging.

Note

When this function is set to [On] while there are clogged nozzles that cannot be cleared by cleaning, automatic cleaning cycle will be performed every time the printer runs an automatic nozzle check so that ink consumption will increase.

To avoid this, select the nozzle pattern that no nozzles are clogged from ["Select Nozzle" P.119](#) beforehand and then set the auto nozzle check to [On].

Automatic nozzle check flow

Note

Normally the detection takes about 3 to 5 minutes, but it may take longer according to the number of clogged nozzles.

1. When nozzle cloggings were detected

- The printer runs an automatic cleaning to clear nozzles.
 - In case the print head has been selected in the ["Head Select" P.116](#), cleaning is performed on the selected print head only.
- Cleaning cycle to be performed is up to three times.

Cleaning

**%

Before Use	Key operation
Basic Operations	Print settings menu
Various Settings	Test Print menu
Maintenance	Maintenance menu
When problems occur	Printer Status menu
Appendix	System Information menu
	Roll Length Manage menu
	Media Adjustment menu
	Ink Agitation menu
	Sleep Mode menu

2. When the active nozzle area was automatically selected

In case nozzle clogging persists after three cleaning attempts, the printer automatically selects in combination of active print head and nozzle area to be able to continue printing with properly firing nozzles.

- While in print ready state, automatically selected print head (number) and nozzle pattern (alphabet), print head (number) only or nozzle pattern (alphabet) only will be displayed on the printer control panel.
- When the print head and the nozzle pattern have been selected from **“Head Select” P.116** , **“Select Nozzle” P.116** , the media width will be displayed on the panel.

```
Print Ready
PG:Low   Nozzle:1A
```

When Head 1 and Nozzle Pattern A are selected

```
Print Ready
PG:Low   Nozzle:2
```

When Head 2 is selected

```
Print Ready
PG:Low   Nozzle:B
```

When Nozzle Pattern B is selected

3. In case nozzle clogging still persists

The message [Auto Nozzle Check Nozzle Clog Present] appears.

If the print job has already been sent to the printer, the job that nozzle clogging was detected will be deleted and the rest of the print jobs will be on hold.

- Delete the job being on hold using the computer that you sent the job, then manually run a nozzle check and cleaning.
 - ☞ **“Run a nozzle check” P.61** , **“Perform a head cleaning” P.65**
- MUTOH recommends you to clear the nozzles and then print the job again.

Tapping  [Enter] key will delete the message and continue printing the job being on hold without clearing nozzles.

```
Auto Nozzle Check
Nozzle Clog Present
```

Before Use

Key operation

Basic Operations

Print settings menu

Various Settings

Test Print menu

Maintenance

Maintenance menu

When problems occur

Printer Status menu

Appendix

System Information menu



Roll Length Manage menu

Media Adjustment menu

Ink Agitation menu

Sleep Mode menu

Test Print menu

Settings menu	Functions
Nozzle Check	Print a nozzle check pattern using the print head and the nozzles selected from the "Head Select" and "Select Nozzle" menus.  "Nozzle check steps" P.62
Nozzle Check F	Prints a nozzle check pattern using all nozzles.  "Nozzle check F steps" P.63
Nozzle Check B *Displays on 6-color configuration only	The nozzle check patterns of the white and color inks will be printed with the background colors so that the nozzle conditions of these colors can be easily observed.  "Nozzle check B steps" P.64
Mode Print	Prints the following settings specified in the currently selected user type: Print mode/ Effect option/ Micro adjustment value of PF Adjust <div style="border: 1px solid black; padding: 5px; text-align: right;">2024/01/01 0:00 Quality/i-Weave UVEx/PF Adjust:0.00%</div>

Before Use	Key operation
Basic Operations	Print settings menu
Various Settings	Test Print menu
Maintenance	Maintenance menu
When problems occur	Printer Status menu
Appendix	System Information menu
	Roll Length Manage menu
	Media Adjustment menu
	Ink Agitation menu
	Sleep Mode menu

Settings menu	Functions	
Adjust Head ☞ "Print head calibration ("Adjust Head")" P.68		This product has two print heads. This menu calibrates ink dot placement position between two print heads.
Auto	All, Standard, Adjust Pattern A,B,D,E	The color sensor reads the adjustment pattern and the printer automatically runs a print head alignment. Auto has the following adjustment patterns: <ul style="list-style-type: none"> • ALL: Runs calibration of all adjustment patterns. • Standard: Runs the same calibration as [Standard]. • Adjust Pattern A,B,D,E: Runs calibration of an adjustment pattern selected from A, B, D or E.
Standard		Align ink dot placement for selected print mode.
Custom	Fine Pattern ALL, Fine Pattern A,B,D,E	Print an adjustment pattern and enter the adjustment value that has least misalignment. Custom has the following adjustment patterns: <ul style="list-style-type: none"> • Fine Pattern ALL: Print all adjustment patterns and run a print head calibration. • Fine Pattern A, B, D, E: Select a pattern from A, B, D or E and run a print head calibration.

Before Use	Key operation
Basic Operations	Print settings menu
Various Settings	Test Print menu
Maintenance	Maintenance menu
When problems occur	Printer Status menu
Appendix	System Information menu
	Roll Length Manage menu
	Media Adjustment menu
	Ink Agitation menu
	Sleep Mode menu

Maintenance menu

Settings menu	Settings range	Functions
Cleaning "Perform a head cleaning" P.65		Perform a head cleaning. You can select a print head to be cleaned and the cleaning mode from the sub menu.
Select Print Head	ALL, Head1, Head2	If the nozzle clogging occurs in either one of the print heads, you can select that print head so that ink consumption can be reduced.
Cleaning Type	Short, Normal, Long, Little Charge, Initial Charge	Select the type of cleaning. <div style="border: 1px solid green; padding: 5px; margin-top: 10px;"> Note [Long], [Little Charge] and [Initial Charge] options will not be displayed when [Head1] or [Head2] is selected. </div>
CR Maintenance "Replacing consumable parts" P.195		Use this menu when replacing the following consumable parts or when cleaning the color sensor. "Cleaning the color sensor" P.191 "Replacing the flushing box pad" P.197 "Replacing the cleaning wiper" P.201 "Replacing Cutter" P.204 "Replace the filter of UV-LED lamp" P.207 "Replace the emitting window glass of the UV-LED lamp" P.209
Ink Discharge		If the printer will not be used for a long period of time, use this menu to flush the ink out of the printer. "When not using the printer for a long period of time" P.216

Before Use	Key operation
Basic Operations	Print settings menu
Various Settings	Test Print menu
Maintenance	Maintenance menu
When problems occur	Printer Status menu
Appendix	System Information menu
	Roll Length Manage menu
	Media Adjustment menu
	Ink Agitation menu
	Sleep Mode menu

Settings menu	Settings range	Functions
Plug Lifetime ☞ "Replace the adapter's plug for high-capacity ink pack adapter" P.166		Use this menu to check and replace the plug for high-capacity ink pack adapter.
Check		Use this menu to check the remaining life of the adapter's plug on the high-capacity ink pack adapter. <ul style="list-style-type: none"> The remaining life of the plug is indicated by the asterisks (Maximum 5 asterisks: 100% left). As the part deteriorates, the number of asterisks decreases one by one (20%). The plug must be replaced when all of the asterisks have disappeared and "Change" is displayed.
Initialize		Reset the life counter of an adapter plug after replacing it. Select an appropriate ink slot and reset the counter.
Soak Cleaning ☞ "Soak Cleaning" P.186		Soak the print head in the maintenance cleaner filled in the head cap to clean dirt on the surface of nozzle. Perform a soak cleaning if nozzle clogging still persists after head cleaning attempt.
Daily Maintenance		Use this menu when you perform a daily maintenance or cleaning each part of the printer. <ul style="list-style-type: none"> ☞ "Daily maintenance at the end of work" P.171 ☞ "Cleaning each part of the printer" P.189

Before Use

Key operation

Basic Operations

Print settings menu

Various Settings

Test Print menu

Maintenance

Maintenance menu

When problems occur

Printer Status menu

Appendix

System Information menu





Roll Length Manage menu

Media Adjustment menu

Ink Agitation menu

Sleep Mode menu

Printer Status menu

Settings menu	Settings range	Functions
Ink		<p>Displays the ink level in percentage per ink slot.</p> <div style="border: 1px solid green; padding: 5px;"> <p> Note</p> <p>If the ink level blinks at 10 percent, the smartchip recovery is being performed on the corresponding ink.</p> <p> "Smartchip recovery" P.237</p> </div>
Life Times	Head 1, Head 2, CR Motor, PF Motor, Pump 1, Pump 2, Circulation Pump, UV lamp L, UV lamp R,	<p>Displays remaining life of the parts that need to be replaced.</p> <ul style="list-style-type: none"> The remaining life is indicated by the asterisks (Maximum 5 asterisks: 100% left). As the part deteriorates, the number of asterisks decreases one by one (20%). If all asterisks disappear and [Change] is displayed, request parts replacement as soon as possible. <p>Once the status becomes [Change], the message like [Pump1: Change] will appear while you do not access to a menu. This message can be deleted by tapping  [Cancel] key.</p>
Job Status		
	 "Job status" P.102	
Job Status		If printing is complete, [Completed] will be displayed. If printing is cancelled, [Cancelled] will be displayed.
ToDoLength		Displays the length of the print data.
Done		Displays the length printed.
Remain		Displays the length of data which has not been printed yet.

Before Use	Key operation
Basic Operations	Print settings menu
Various Settings	Test Print menu
Maintenance	Maintenance menu
When problems occur	Printer Status menu
Appendix	System Information menu
	Roll Length Manage menu
	Media Adjustment menu
	Ink Agitation menu
	Sleep Mode menu

Settings menu	Settings range	Functions
Total Print Area		Displays the total printed area.
Ink expiration		Displays ink expiration date. • "----/--/--" is displayed for the slot where the smartchip recovery is being performed.  "Smartchip recovery" P.237

Before Use	Key operation
Basic Operations	Print settings menu
Various Settings	Test Print menu
Maintenance	Maintenance menu
When problems occur	Printer Status menu
Appendix	System Information menu
	Roll Length Manage menu
	Media Adjustment menu
	Ink Agitation menu
	Sleep Mode menu

System Information menu

Display printer information.

Settings menu	Functions
Version	Displays the firmware version (M: main firmware, C: controller firmware).
Printer Model	Displays the printer model name.
Serial Number	Displays the serial number of the printer.
Ink Type	Displays the ink type loaded on the printer.

Before Use	Key operation
Basic Operations	Print settings menu
Various Settings	Test Print menu
Maintenance	Maintenance menu
When problems occur	Printer Status menu
Appendix	System Information menu
	Roll Length Manage menu
	Media Adjustment menu
	Ink Agitation menu
	Sleep Mode menu

Roll Length Manage menu

This menu allows you to manage the remaining length information of roll media being loaded in the printer. Before replacing with another roll media, you can print this information on the roll media with text and a code. The next time when the roll media is loaded, the printer will read the code and manage the remaining length.

Note

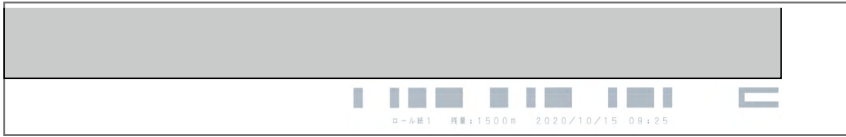
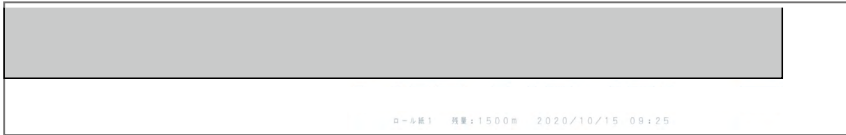

- "Print" or "Simple Print" requires at least 400 mm printable width. Before printing, make sure that there is sufficient width on the media.
If printable width is less than 400 mm, the printer will not perform printing. Printable width on the media can be adjusted by changing CR origin and side margin (left and right side margin) settings.
☞ "Media Width" P.111 , "Origin" P.112 , "Side Margin" P.111
- The Roll Length Manage menu will not be displayed when the Media Initial menu is set to [Off].
☞ "Media Initial" P.111
- This Roll Length Manage menu will not be displayed when no roll media is loaded in the printer.

Submenu	Settings range	Functions
Print		<p>After cutting the print off the roll media, print a roll remaining length management information (roll media type, remaining length, date printed, roll length management code) on the roll media. This information cannot be printed when the "Roll Length" P.132 is set to [Off].</p> 
Simple Print		<p>After cutting the print off the roll media, print a roll remaining length management information (roll media type, remaining length, date printed) on the roll media. This information cannot be printed when the "Roll Length" P.132 is set to [Off].</p> 

Before Use	Key operation
Basic Operations	Print settings menu
Various Settings	Test Print menu
Maintenance	Maintenance menu
When problems occur	Printer Status menu
Appendix	System Information menu
	Roll Length Manage menu
	Media Adjustment menu
	Ink Agitation menu
	Sleep Mode menu

Submenu	Settings range	Functions
Scan "Scan" P.133		The printer scans the roll length management code printed on the roll media. When failed to read the code, the "Roll Length" P.132 menu will be displayed. Enter the roll length manually.
Roll Length	<u>Off</u> , Roll 1 to Roll 3	The length of up to three roll media to be loaded can be specified. Selecting one other than [Off] and tapping [Enter] key will go to the Length menu.
Length	1 to <u>30</u> to 200m	Length of roll media can be entered by 1 m increments. Tapping [Enter] key will go to the Print Stop menu.
Print Stop	<u>Off</u> , On	Select whether or not to pause printing when the remaining roll length counter reached zero. <ul style="list-style-type: none"> • Off: Printing pauses when the rear sensor responds. • On: When the remaining length counter reached zero, the printer gives [Roll Remain Error] message and pauses printing. If a roll media does not release easily from the paper core, you should select [On]. In the [On] setting, tapping key will go to the Near End menu.
Near End	<u>Off</u> , 1 to 10m	Select whether to display the remaining roll length on the control panel before the counter reaches 0. <ul style="list-style-type: none"> • Off: Remaining length is not displayed. • Remain **m (** can be specified between 1 to 10): "Near End" is displayed when the counter reached the length you specified.
Auto Scan	<u>Off</u> , On	Select whether or not the printer automatically scans the remaining length management code. <ul style="list-style-type: none"> • Off: The printer does not automatically read the code. • On: The printer automatically scans the remaining length management code when <ul style="list-style-type: none"> - the printer is powered on. - you replace with a different media. Tapping [Cancel] key while scanning will cancel the scan. <div style="border: 1px solid green; padding: 5px; margin-top: 10px;"> <p> Note</p> <ul style="list-style-type: none"> • The printer may fail to scan if a remaining length management code has dirt or fold marks on it. In case the printer failed to scan the code, manually specify the Roll Length settings based on the remaining length management information printed in text on the media. • In case the printer is unable to read the code even if this setting is [ON], check that the following settings are set to [OFF] or [Auto cut]. <p> "Roll Length" P.132</p> <p> "Media Initial" P.111, "Output Mode" P.111</p> </div>



Before Use	Key operation
Basic Operations	Print settings menu
Various Settings	Test Print menu
Maintenance	Maintenance menu
When problems occur	Printer Status menu
Appendix	System Information menu
	Roll Length Manage menu
	Media Adjustment menu
	Ink Agitation menu
	Sleep Mode menu

Submenu	Settings range	Functions
Auto Print	Off ,On	<p>Select whether or not to prompt a confirmation message when you perform media cutting, asking you whether to print a remaining length management information on a roll media.</p> <ul style="list-style-type: none"> Off: This message is not prompted. On: The confirmation message [Print Roll's Remain?] appears after you perform media cutting. Select [Yes] or [No] and tap  [Enter] key. <div style="border: 1px solid green; padding: 5px; margin-top: 10px;"> <p> Note</p> <p>The Auto Print menu cannot be enabled when the Roll Length menu is set to [Off].</p> <p> "Roll Length" P.132</p> </div>

Scan

Scan the remaining length management code.

- 1 Load a roll media that the remaining length management code has been printed on into the printer.

 -  ["Loading a roll media into the printer" P.49](#)
 -  ["Print" P.131](#)
- 2 Check that the code printed on the media has passed through the pressure rollers.

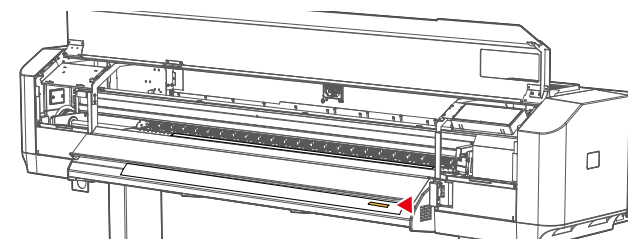

Before Use	Key operation
Basic Operations	Print settings menu
Various Settings	Test Print menu
Maintenance	Maintenance menu
When problems occur	Printer Status menu
Appendix	System Information menu
	Roll Length Manage menu
	Media Adjustment menu
	Ink Agitation menu
	Sleep Mode menu

3 Access to the Roll Length Manage Scan menu.

- Tap [Home] key so that [Menu1 Setup] appears.
- Use / key to select [Menu6 Roll Length Manage].
- Tap key. [Roll Length Manage Print] appears.
- Use / key to select [Roll Length Manage3 Scan].

4 Tap [Enter] key so that the printer begins scanning the code.

- Tapping key while scanning will cancel the scan.

5 When the printer scanned the code successfully, the following settings will automatically be specified in Roll Length:

Type of roll media, Remaining roll length

["Roll Length" P.132](#)

Note

• **The printer may fail to scan if a remaining length management code has dirt or fold marks on it. In case failed to scan the code, manually specify the Roll Length settings based on the remaining length management information printed in text on the media.**

["Roll Length" P.132](#)

• **The printer is unable to scan the code when the Output Mode menu is set to [Take Up].**

["Output Mode" P.111](#)

Before Use	Key operation
Basic Operations	Print settings menu
Various Settings	Test Print menu
Maintenance	Maintenance menu
When problems occur	Printer Status menu
Appendix	System Information menu
	Roll Length Manage menu
	Media Adjustment menu
	Ink Agitation menu
	Sleep Mode menu



Media Adjustment menu

The printer automatically runs print quality calibration and media feed adjustment.

Note

- This menu prints an adjustment pattern. To print it, more than 550 mm of printable area is required. If less than 550 mm, calibration cannot be performed.
- Changing the origin setting for CR and the left and right side margins with reference to the width of media loaded can increase or decrease the width of printable area.
 - ☞ ["Media Width" P.111](#) , ["Origin" P.112](#) , ["Side Margin" P.111](#)
- If print quality (banding or graininess appears) does not improve even after this calibration was performed, run a Media Adjustment again or perform [Custom] calibration from the Adjust Print menu.
 - ☞ ["Print quality calibration \("Adjust Print"\)" P.72](#)

1 Access to the Media Adjustment menu.

- Tap  [Home] so that [Menu1 Setup] appears.
- Use  /  key to select [Menu7 Media Adjustment].

2 Tap key.

- [User Type Type*] appears.



Note

The user type number currently selected is displayed in "##".

3 Use / key to select a user type.

- Tap  key. The user type being selected is switched to the one you just selected.
- The display goes to the Thickness menu.

Before Use	Key operation
Basic Operations	Print settings menu
Various Settings	Test Print menu
Maintenance	Maintenance menu
When problems occur	Printer Status menu
Appendix	System Information menu
	Roll Length Manage menu
	Media Adjustment menu
	Ink Agitation menu
	Sleep Mode menu

-
- 4** Enter the thickness of media.
-  /  key: Enter the thickness.
 -  [Enter] key : Confirm the thickness.

 **Note**

The change made here is saved in the user type.

-
- 5** An adjustment pattern is printed automatically.
The color sensor reads the pattern and the printer begins automatic calibration.
- Once the calibration is finished, the message [AutoAdjust Succeeded/OK -> Enter] appears.
 - When the calibration is failed, the message [AutoAdjust Failed/ OK -> Enter] appears. Run a calibration manually.
-  ["Print quality calibration \("Adjust Print\)" P.72 , "Media feed adjustment" P.78](#)

-
- 6** Tap  [Enter] key to end the calibration.
-

Before Use

Basic Operations

Various Settings

Maintenance

When problems occur

Appendix

Key operation

Print settings menu

Test Print menu

Maintenance menu

Printer Status menu

System Information menu

Roll Length Manage menu

Media Adjustment menu

Ink Agitation menu



Sleep Mode menu

Ink Agitation menu

This menu allows you to immediately perform ink agitation or check the time until the next ink agitation is required.

Printing operation after the message "Agitate * Ink" (ink agitation message) was displayed can also be specified.

* In "*" , KMCYW, KMCY or W is displayed for 6-color configuration printer and ALL is displayed for 4-color configuration printer.

Submenu	Functions
Perform	Select an ink and agitate it.  "Agitating ink" P.145
Next time	Displays the time until the next ink agitation is required.  "Agitating ink" P.145
Print Stop	Specify whether or not to stop a new job printing while an ink agitation message is displayed.

Print Stop setting

Specify whether or not to stop a new job printing while an ink agitation message is displayed.

*An ink agitation message is displayed 12 hours for white (Wh) ink and 72 hours for color (CMYK) ink after the last ink agitation.

Print Stop: On (default)

- If the time elapsed since the ink agitation message display is less than 12 hours, the printer will have waiting time before printing to encourage ink agitation. Printing will begin after a certain time.
- If 12 hours has passed, you are unable to print unless you perform ink agitation. This is to avoid poor print results by using settled ink.
- When an ink agitation message appears, make sure to agitate ink.

Before Use	Key operation
Basic Operations	Print settings menu
Various Settings	Test Print menu
Maintenance	Maintenance menu
When problems occur	Printer Status menu
Appendix	System Information menu
	Roll Length Manage menu
	Media Adjustment menu
	Ink Agitation menu
	Sleep Mode menu

Print Stop: Off

Important !!

If the Print Stop menu is set to [Off] and you continue to use your printer without ink agitation, the following symptoms occur in your print:

- Mottling appears on the print or color of the print is different from the color of the image as the ink in the ink cartridge (or ink bag) settles and high density ink is jetted first.
- Continued use in the above condition will result in low density ink remaining in the ink cartridge (ink bag) and color will be gradually fade.

If the above symptom appears, you cannot recover the printer with correct color just by ink agitation.

To recover, you have to flush ink out of the printer and perform initial ink charging using new ink.

 **"2. Flush ink out of printer" P.216**

 **"Initial ink charging after flushing ink out of the printer" P.222**

When changing the Print Stop setting, be aware that the above symptoms could occur with [Off] setting. MUTOH cannot guarantee the print quality with the Print Stop menu set to [Off].

- You can continue to print regardless of time elapsed since the ink agitation message display.
- In addition,
 - there is no waiting time for ink agitation before printing.
 - printing will not be suspended due to not agitating the ink for a long time.
- The Off setting can be used for long-time continuous printing by sending multiple print jobs (like overnight unattended printing, etc.)

Example) After 10 hours since the last white (Wh) ink agitation, if you send 20 copies of a job which takes one hour to complete printing to the printer,

When the Print Stop menu is set to [On]: After the second copy is printed, the printer waits for a certain time each time before printing until the thirteenth copy, but stops printing from the fourteenth copy.

When the Print Stop menu is set to [Off]: the printer can print 20 copies.

Note

In order to maintain print quality as well as ink quality, MUTOH recommends that you set the Print Stop menu to [On] even if you want to print continuously for a long time and agitate ink before printing from the ink agitation menu or direct key.

 **"When agitating ink whenever you want" P.148**

Before Use	Key operation
Basic Operations	Print settings menu
Various Settings	Test Print menu
Maintenance	Maintenance menu
When problems occur	Printer Status menu
Appendix	System Information menu
	Roll Length Manage menu
	Media Adjustment menu
	Ink Agitation menu
	Sleep Mode menu

1 Tap [Home] key so that [Menu1 Setup] appears.
Use / key to choose [Menu8 Ink agitation].



2 Tap key.
The message [Ink agitation1 Perform] appears.

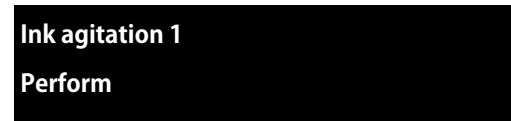

3 Use / key to choose [Ink agitation3 Print Stop].



4 Use / key to select whether or not to stop a new job printing while the ink agitation message is displayed.

- On: If more than 12 hours has passed since the ink agitation message display, you are unable to print a new job. Printing will become available once ink agitation is finished.

["Agitating ink" P.145](#)

- Off: A new job printing is available even while the ink agitation message appears.



5 Tap [Enter] key

- When "On" is selected, the display returns to the Ink Agitation menu.
- When "Off" is selected, move to step 6.

Note

When "Off" is selected, the setting has not been confirmed at this point.

Before Use	Key operation
Basic Operations	Print settings menu
Various Settings	Test Print menu
Maintenance	Maintenance menu
When problems occur	Printer Status menu
Appendix	System Information menu
	Roll Length Manage menu
	Media Adjustment menu
	Ink Agitation menu
	Sleep Mode menu

6 When "Off" is selected, a warning message appears.



7 Use / key to select [Yes] or [No].

- Tap [Enter] key to confirm the setting.
 - When confirmed on [No], this option is set to [On].
 - When confirmed on [Yes], it is set to [Off].

If printing is continued while the ink agitation message appears, the print may be mottled or color of the print might be different from the color of the image.



"Important!!" P.138



Before Use	Key operation
Basic Operations	Print settings menu
Various Settings	Test Print menu
Maintenance	Maintenance menu
When problems occur	Printer Status menu
Appendix	System Information menu
	Roll Length Manage menu
	Media Adjustment menu
	Ink Agitation menu
	Sleep Mode menu

Sleep Mode menu

In this menu, you can put the printer into sleep mode.

Settings menu	Settings range	Functions
Start		Put the printer into sleep mode. Follow the instructions on the panel to perform a daily maintenance when entering to sleep mode.  "Sleep Mode" P.103  "Daily maintenance at the end of work" P.171

Maintenance

About Maintenance 143

Wearing protective equipment 144

Agitating ink 145

Checking ink level and replacing cartridge 158

Emptying waste ink tank 167

Daily maintenance at the end of work 171

Printer maintenance 185

Replacing consumable parts 195

When not using the printer for a long period of time 216

Moving or transporting the printer 218

Before Use

Basic Operations

Various Settings

Maintenance

When problems occur

Appendix

About Maintenance

Wearing protective equipment

Agitating ink

Checking ink level and replacing cartridge

Emptying waste ink tank

Daily maintenance at the end of work

Printer maintenance

Replacing consumable parts

When not using the printer for a long period of time

Moving or transporting the printer

About Maintenance

To maintain the performance of this product, please conduct maintenance by yourself.

The types of maintenance are shown here.

Before daily operation	 "Nozzle check and cleaning" P. 61
After daily operation	 "Daily maintenance at the end of work" P. 171
When needed	 "Replacing with a new ink" P. 160
	 "Emptying waste ink tank" P. 167
	 "Head cleaning" P. 185
	 "Soak Cleaning" P. 186
	 "Cleaning the color sensor" P. 191
	 "Replacing the flushing box pad" P. 197
	 "Replacing the cleaning wiper" P. 201
	 "Replacing Cutter" P. 204
	 "Replace the filter of UV-LED lamp" P. 207
	 "Replace the emitting window glass of the UV-LED lamp" P. 209
 "Replacing and cleaning the exhaust fan filter" P. 212	
Monthly	 "Cleaning inside the printer" P. 193
When not used for a week or more	 "Head cleaning" P. 185 (Once a week)
When not used for a long period	 "When not using the printer for a long period of time" P. 216

Important !!

In following cases, please contact your local MUTOH dealer to request service personnel.

- The same system error occurred repeatedly.
- The message notifying the life of motors, pumps or print head is displayed on the control panel.

 ["Messages and Error Messages" P. 228](#)

Before Use

Basic Operations

Various Settings

Maintenance

When problems occur

Appendix

About Maintenance

Wearing protective equipment

Agitating ink

Checking ink level and replacing cartridge

Emptying waste ink tank

Daily maintenance at the end of work

Printer maintenance

Replacing consumable parts

When not using the printer for a long period of time

Moving or transporting the printer

Wearing protective equipment

For the following tasks, make sure to wear protective equipment such as supplied gloves (or solvent-resistant gloves) and goggles.

- “Checking ink level and replacing cartridge” P. 158
- “Emptying waste ink tank” P. 167
- “Daily maintenance at the end of work” P. 171
- “Soak Cleaning” P. 186
- “Cleaning the color sensor” P. 191
- “Cleaning inside the printer” P. 193
- “Replacing the flushing box pad” P. 197
- “Replacing the cleaning wiper” P. 201
- “Replace the filter of UV-LED lamp” P. 207
- “Replace the emitting window glass of the UV-LED lamp” P. 209
- “Replacing and cleaning the exhaust fan filter” P. 212

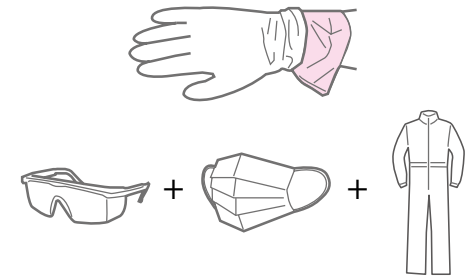

How to wear the supplied gloves

Wear the rubber gloves over the polyethylene gloves (pink).



Caution



Do not touch uncured ink with bare hand.



- If glove becomes contaminated with ink, replace with new ones.
- If your clothes are contaminated with ink, immediately take it off. Wash it before reuse.
- If ink gets on skin, immediately wash with soap and plenty of water for 15 minutes. Seek medical advice/attention if irritation or inflammation are present.
- If ink gets in eyes, flush eyes with plenty of water for 15 minutes and seek medical advice/attention immediately.
- If swallowed, rinse mouth immediately and do not induce vomiting. Seek medical advice/attention.

Before Use

Basic Operations

Various Settings

Maintenance

When problems occur

Appendix

About Maintenance

Wearing protective equipment

Agitating ink

Checking ink level and replacing cartridge

Emptying waste ink tank

Daily maintenance at the end of work

Printer maintenance

Replacing consumable parts

When not using the printer for a long period of time

Moving or transporting the printer

Agitating ink

To avoid ink settling, you must agitate the ink in the ink cartridges (ink bags) in the following timing:

- When you open a new ink cartridge or ink bag.
- When the following message appears on the control panel.

- for 6-color configuration.

Agitate W Ink

Agitate White (Wh) inks.

- This message appears every 12 hours.

Agitate KMCY Ink

Agitate Black (K), Magenta (M), Cyan (C) and Yellow (Y) inks.

- This message appears every 72 hours.

Agitate KMCYW Ink

Agitate Black (K), Magenta (M), Cyan (C), Yellow (Y) and White (Wh) inks.

- This message appears every 72 hours.

- for 4-color configuration.

Agitate ALL Ink

Agitate Black (K), Magenta (M), Cyan (C) and Yellow (Y) inks.

- This message appears every 72 hours.

<div style="border: 1px solid black; padding: 5px; margin-bottom: 10px; text-align: center;">Before Use</div> <div style="border: 1px solid black; padding: 5px; margin-bottom: 10px; text-align: center;">Basic Operations</div> <div style="border: 1px solid black; padding: 5px; margin-bottom: 10px; text-align: center;">Various Settings</div> <div style="border: 1px solid black; padding: 5px; margin-bottom: 10px; text-align: center; background-color: #1a3d54; color: white;">Maintenance</div> <div style="border: 1px solid black; padding: 5px; margin-bottom: 10px; text-align: center;">When problems occur</div> <div style="border: 1px solid black; padding: 5px; text-align: center;">Appendix</div>	<div style="border: 1px solid #ccc; border-radius: 15px; padding: 10px; margin-bottom: 10px; text-align: center;">About Maintenance</div> <div style="border: 1px solid #ccc; border-radius: 15px; padding: 10px; margin-bottom: 10px; text-align: center;">Wearing protective equipment</div> <div style="border: 1px solid #ccc; border-radius: 15px; padding: 10px; margin-bottom: 10px; text-align: center; background-color: #1a3d54; color: white;">Agitating ink</div> <div style="border: 1px solid #ccc; border-radius: 15px; padding: 10px; margin-bottom: 10px; text-align: center;">Checking ink level and replacing cartridge</div> <div style="border: 1px solid #ccc; border-radius: 15px; padding: 10px; margin-bottom: 10px; text-align: center;">Emptying waste ink tank</div> <div style="border: 1px solid #ccc; border-radius: 15px; padding: 10px; margin-bottom: 10px; text-align: center;">Daily maintenance at the end of work</div> <div style="border: 1px solid #ccc; border-radius: 15px; padding: 10px; margin-bottom: 10px; text-align: center;">Printer maintenance</div> <div style="border: 1px solid #ccc; border-radius: 15px; padding: 10px; margin-bottom: 10px; text-align: center;">Replacing consumable parts</div> <div style="border: 1px solid #ccc; border-radius: 15px; padding: 10px; margin-bottom: 10px; text-align: center;">When not using the printer for a long period of time</div> <div style="border: 1px solid #ccc; border-radius: 15px; padding: 10px; text-align: center;">Moving or transporting the printer</div>
---	---

 **Note**

When the Print Stop menu is set to [Off], these messages will be changed to the following ones:
 This is to make sure to pay more attention for ink agitation.

 ["Print Stop setting" P. 137](#)

```

■■■■■■ CAUTION ■■■■■■
A g i t a t e  W  I n k
  
```

```

■■■■■■ CAUTION ■■■■■■
A g i t a t e  K M C Y  I n k
  
```

```

■■■■■■ CAUTION ■■■■■■
A g i t a t e  K M C Y W  I n k
  
```

```

■■■■■■ CAUTION ■■■■■■
A g i t a t e  A L L  I n k
  
```

Before Use

About Maintenance

Basic Operations

Wearing protective equipment

Various Settings

Agitating ink

Maintenance

Checking ink level and replacing cartridge

When problems occur

Emptying waste ink tank

Appendix

Daily maintenance at the end of work

Printer maintenance

Replacing consumable parts

When not using the printer for a long period of time

Moving or transporting the printer

Important!

- You must agitate ink in the ink cartridges (ink bags) regularly. Failure to do so could cause ink settling, leading to print defects or printer failure.
- The agitate ink message for Black (K), Magenta (M), Cyan (C), Yellow (Y) inks may sometimes appear at the same timing as the one for White (Wh) ink.
- Until 12 hours after the ink agitation message display, the printer will have waiting time before printing in order to encourage ink agitation. Printing will begin after ink agitation is performed or a certain period has passed.
- If 12 hours has passed, you are unable to print unless you perform ink agitation.

*When the Print Stop menu is set to [Off], the printer will operate as follows:

- After the ink agitation message display, printing begins without certain waiting time.
- Printing can be carried out even after 12 hours since the ink agitation message display.

MUTOH cannot guarantee the print quality with the Print Stop set to Off.

 ["Print Stop setting" P. 137](#)

If printing is carried out while the ink agitation message appears, the message will be changed to the following one:

**I n k - a g i t a t e
a f t e r p r i n t i n g .**

Once printing is finished, agitate ink.

Important!

- Do not remove cartridges while printing. The printing will be paused resulting in poor print quality.



Caution



If UV inks or waste fluids come in contact with skin or eyes, it may induce allergic reaction or inflammation. When you do this operation, always wear protective gloves (such as solvent-resistant gloves) and goggles to avoid contact with skin or eyes.

Before Use	About Maintenance
Basic Operations	Wearing protective equipment
Various Settings	Agitating ink
Maintenance	Checking ink level and replacing cartridge
When problems occur	Emptying waste ink tank
Appendix	Daily maintenance at the end of work
	Printer maintenance
	Replacing consumable parts
	When not using the printer for a long period of time
	Moving or transporting the printer

When agitating ink whenever you want

You can agitate ink at your convenient timing even before the "Agitate Ink" message is prompted.

- If you want to print overnight or continuously, you can agitate ink beforehand to allow for a smooth and consistent printing.

There are two methods as follows:

- "Agitating ink from "Menu 8 Ink Agitation"" P.148
- "Agitating ink from the direct key" P.150

Note

- "You can also check the time until the next ink agitation from the Ink Agitation menu." P. 152

Agitating ink from "Menu 8 Ink Agitation"

- 1 Tap [Home] key so that [Menu1 Setup] appears.
Use / key to choose [Menu8 Ink agitation].

Menu 8
Ink agitation

- 2 Tap key.
The message [Ink agitation1: Perform] appears.

Ink agitation 1
Perform

- 3 Tap key so that [target ink: KMCYW] appears.



Target ink :

K M C Y W

Note

For 4-color configuration, "ALL" is displayed in the target ink.

Before Use	About Maintenance
Basic Operations	Wearing protective equipment
Various Settings	Agitating ink
Maintenance	Checking ink level and replacing cartridge
When problems occur	Emptying waste ink tank
Appendix	Daily maintenance at the end of work
	Printer maintenance
	Replacing consumable parts
	When not using the printer for a long period of time
	Moving or transporting the printer

- 4** Use  /  key to select an ink color you want to agitate.
- KMCYW: Select this when you want to agitate Black (K), Magenta (M), Cyan (C), Yellow (Y), White (Wh) inks.
 - KMCY: Select this when you want to agitate Black (K), Magenta (M), Cyan (C), Yellow (Y) inks.
 - W: Select this when you want to agitate White (Wh) ink.

 **Note**

If a message "Agitate xx Ink" is already displayed on the control panel, the ink selection options will be changed as follows:

For example)

- When "Agitate KMCY Ink" appears: "KMCYW" or "KMCY" is selectable.
- When "Agitate W Ink" appears: "KMCYW" or "W" is selectable.
- When "Agitate KMCYW Ink" appears: Only "KMCYW" is selectable.

This is to ask you to agitate the ink as indicated by the message.

- 5** Tap  [Enter] key to confirm the selection so that the message asking you to agitate your selected inks will appear.
- Agitate the ink colors displayed on the control panel.
 - Once you have agitated all the inks displayed, the message will disappear.



 **Note**

When the Print Stop menu is set to [Off], this message will be changed to the following one:



Before Use	About Maintenance
Basic Operations	Wearing protective equipment
Various Settings	Agitating ink
Maintenance	Checking ink level and replacing cartridge
When problems occur	Emptying waste ink tank
Appendix	Daily maintenance at the end of work
	Printer maintenance
	Replacing consumable parts
	When not using the printer for a long period of time
	Moving or transporting the printer



Agitating ink from the direct key

- 1 While either one of these messages appears on the control panel, tap  [Enter] key.



Print Ready 
PG:Low W:1625mm

or

Media End
PG:Low

- 2 The time until the next ink agitation is required is displayed.
 - Using  /  key, you can check the time for Black (K), Magenta (M), Cyan (C), Yellow (Y) and White (W).

Note

For 4-color configuration, "ALL" is displayed and there is no need to switch display using  /  key.

Until agitation
K M C Y : 4 8 h

Until agitation
W: < 1 h

Time is shown in 1-hr increments.
For example)

- Time for the next agitation is more than 2 hours but less than 3 hours: "2h" appears.
- Time for the next agitation is more than 1 hour but less than 2 hours: "1h" appears.
- Time for the next agitation is less than 1 hour: "<1h" appears.
- When the message "Agitate xx Ink" is already displayed: "Immediately" appears.

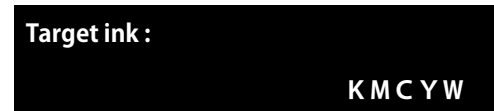

Before Use	About Maintenance
Basic Operations	Wearing protective equipment
Various Settings	Agitating ink
Maintenance	Checking ink level and replacing cartridge
When problems occur	Emptying waste ink tank
Appendix	Daily maintenance at the end of work
	Printer maintenance
	Replacing consumable parts
	When not using the printer for a long period of time
	Moving or transporting the printer

3 Tap  key so that [target ink: KMCYW] appears.



 **Note**

For 4-color configuration, "ALL" is displayed in the target ink.

4 Use  /  key to select an ink color you want to agitate.

- KMCYW : Select this when you want to agitate Black (K), Magenta (M), Cyan (C), Yellow (Y), White (Wh) inks.
- KMCY : Select this when you want to agitate Black (K), Magenta (M), Cyan (C), Yellow (Y) inks.
- W : Select this when you want to agitate White (Wh) ink.

 **Note**

If a message "Agitate xx Ink" is already displayed on the control panel, the ink selection options will be changed as follows:

For example)

- When "Agitate KMCY Ink" appears: "KMCYW" or "KMCY" is selectable.
- When "Agitate W Ink" appears: "KMCYW" or "W" is selectable.

This is to ask you to agitate the ink as indicated by the message.

5 Tap  [Enter] key to confirm the selection so that the message asking you to agitate your selected inks will appear.



- Agitate the ink colors displayed on the control panel.
- Once you have agitated all the inks displayed, the message will disappear.

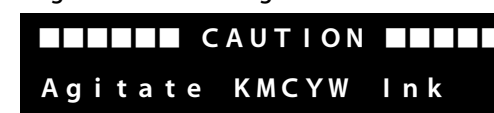

 **Note**

When the Print Stop menu is set to [Off], this message will be changed to the following one:



Before Use	About Maintenance
Basic Operations	Wearing protective equipment
Various Settings	Agitating ink
Maintenance	Checking ink level and replacing cartridge
When problems occur	Emptying waste ink tank
Appendix	Daily maintenance at the end of work
	Printer maintenance
	Replacing consumable parts
	When not using the printer for a long period of time
	Moving or transporting the printer

You can also check the time until the next ink agitation from the Ink Agitation menu.

- 1 Tap  [Home] key so that [Menu1 Setup] appears.
Use  /  key to choose [Menu8 Ink agitation].

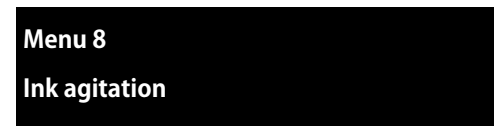

- 2 Tap  key.
The message [Ink agitation1: Perform] appears.

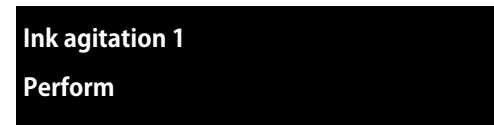

- 3 Use  key to choose [Ink agitation2 Sleep Next time].

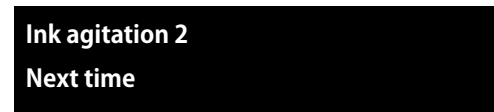

Before Use

About Maintenance

Basic Operations

Wearing protective equipment

Various Settings

Agitating ink

Maintenance

Checking ink level and replacing cartridge

When problems occur

Emptying waste ink tank

Appendix

Daily maintenance at the end of work

Printer maintenance

Replacing consumable parts

When not using the printer for a long period of time

Moving or transporting the printer

- 4** The time until the next ink agitation is required is displayed.
- KMCY: Black (K), Magenta (M), Cyan (C), Yellow (Y)
 - W: White (Wh)

KMCY:	4 8 h
W:	< 1 h

Time is shown in 1-hr increments.
For example)

- Time for the next agitation is more than 2 hours but less than 3 hours: "2h" appears.
- Time for the next agitation is more than 1 hour but less than 2 hours: "1h" appears.
- Time for the next agitation is less than 1 hour: "<1h" appears.
- When the message "Agitate xx Ink" is already displayed: "Immediately" appears.

Note



For 4-color configuration, "ALL: 48h" appears.

Note

Tapping  key will move to the ink agitation menu.

- If you want to perform ink agitation, select "Perform".

For details, see "Agitating ink from "Menu 8 Ink Agitation"" P.148

- 5** Once you finish checking the time, tap  key to return to the ink agitation menu.
By tapping  the display will return to [Print Ready].

Print Ready	
PG: Low	W: 1625mm

Before Use

Basic Operations

Various Settings

Maintenance

When problems occur

Appendix

About Maintenance

Wearing protective equipment

Agitating ink

Checking ink level and replacing cartridge

Emptying waste ink tank

Daily maintenance at the end of work

Printer maintenance

Replacing consumable parts

When not using the printer for a long period of time

Moving or transporting the printer

When using ink cartridges

1 Remove the ink cartridge from the ink slot.

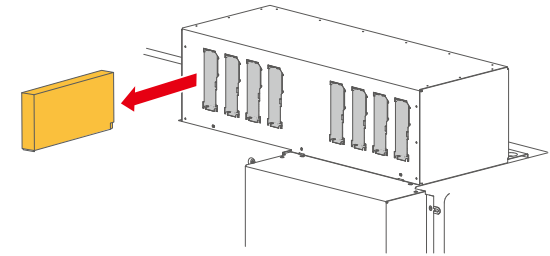

2 Using the paper towel provided with the printer, wipe off the ink around the ink outlet of the cartridge.

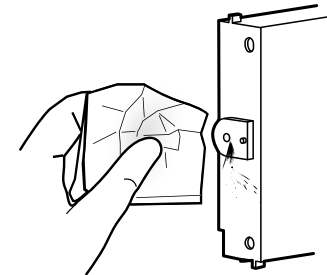

Before Use

Basic Operations

Various Settings

Maintenance

When problems occur

Appendix

About Maintenance

Wearing protective equipment

Agitating ink

Checking ink level and replacing cartridge

Emptying waste ink tank

Daily maintenance at the end of work

Printer maintenance

Replacing consumable parts

When not using the printer for a long period of time

Moving or transporting the printer

3 Follow these steps to agitate ink in the cartridge.

- Hold the ink cartridge with the ink outlet facing up and wait for three seconds.
- Invert it with the ink outlet facing down and wait for three seconds.
- Repeat this ten times.

Note

There is no need to agitate varnish ink.

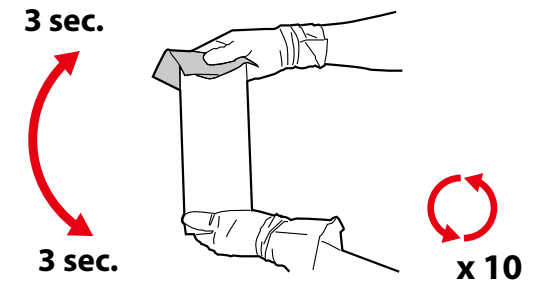

4 Insert the ink cartridge back to the original ink slot.

- Make sure to match the color of the ink cartridge with the color of the label attached to each ink slot. (This illustration is an example of 4-color configuration)
- Hold the cartridge with the arrow mark facing up.
- Insert it all the way in.

Important !!

Make sure you insert it in the original ink slot. Do not insert in a different ink slot even if it is the same color.

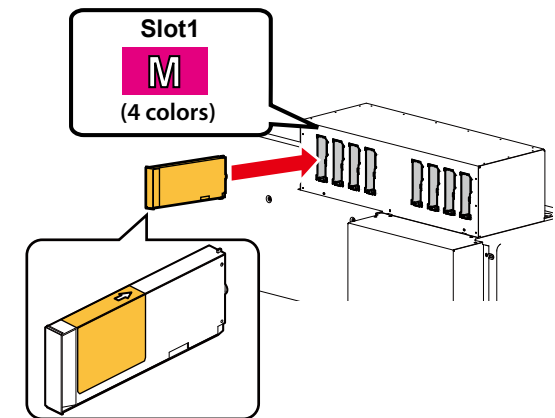

Before Use

Basic Operations

Various Settings

Maintenance

When problems occur

Appendix

About Maintenance

Wearing protective equipment

Agitating ink

Checking ink level and replacing cartridge

Emptying waste ink tank

Daily maintenance at the end of work

Printer maintenance

Replacing consumable parts

When not using the printer for a long period of time

Moving or transporting the printer

When using ink bags with high-capacity ink pack adapters

Note

For proper instructions of high-capacity ink pack adapter, see the high-capacity ink pack adapter's operation manual.

- 1 Remove the high-capacity ink pack adapter from the ink slot.

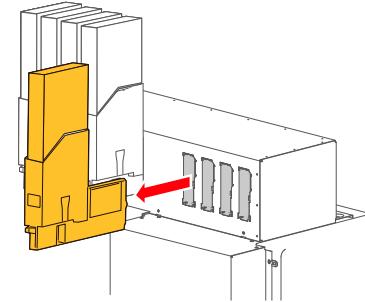

- 2 Using the paper towel provided with the printer, wipe off the ink around the ink outlet of the high-capacity ink pack adapter.

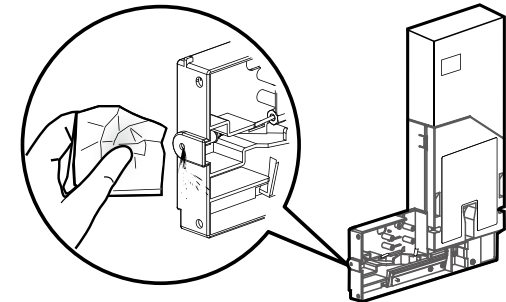

- 3** Tilt the adapter and absorb the ink dripping off the adapter using a cleaning stick.
- Tilt it with the ink outlet slightly facing down.
 - When tilting the adapter, make sure that the side with the warning label attached is facing down.

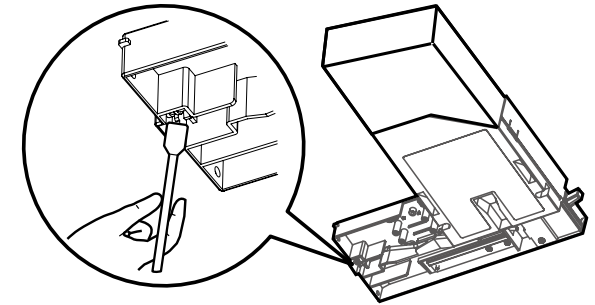

- 4**
- Hold the high-capacity ink pack adapter as shown by holding the light blocking cover down with one hand, making sure not to remove the ink bag from the adapter, and wait for three seconds.
 - Then invert it and wait for three seconds.
 - Repeat this ten times.

 **Note**

There is no need to agitate varnish ink.

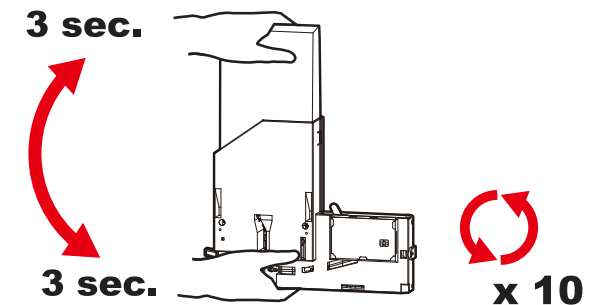

- 5** Insert the high-capacity ink pack adapter back to the original ink slot.
- Make sure to match the color of the ink bag with the color of the label attached to each ink slot. (This illustration is an example of 4-color configuration)
 - Insert it all the way in so that it is correctly seated.

 **Important !!**

Do not insert in a different ink slot even if it is the same color.

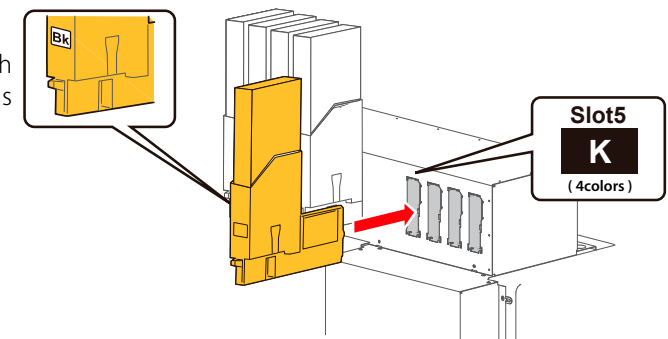

Before Use

About Maintenance

Basic Operations

Wearing protective equipment

Various Settings

Agitating ink

Maintenance

Checking ink level and replacing cartridge

When problems occur

Emptying waste ink tank

Appendix

Daily maintenance at the end of work

Printer maintenance

Replacing consumable parts

When not using the printer for a long period of time

Moving or transporting the printer

Checking ink level and replacing cartridge

For the slot number and the ink color assignments, see below.

["Applying the ink color labels" P.32](#)

Check the ink level

- 1 Check the ink level indicator.
 - To see more details, tap [Home] key.



Note

You can also check the ink level on the MSM remote panel.

["Launching MSM" P.36](#)

- 2 Access to the Printer Status menu.
 - Tap key several times to select [Printer Status1 Ink].
 - Tap key.

- 3 The ink level of each ink cartridge (ink bag) in Slot 1 to Slot 8 is displayed in percentage (0% to 100%).

1 2 3 4	100 / 90 / 80 / 70
5 6 7 8	100 / 90 / 80 / 70

Note

If the ink level blinks at 10 percent, the smartchip recovery is being performed on the corresponding ink.

["Smartchip recovery" P. 237](#)

Before Use

Basic Operations

Various Settings

Maintenance

When problems occur

Appendix

About Maintenance

Wearing protective equipment

Agitating ink

Checking ink level and replacing cartridge

Emptying waste ink tank

Daily maintenance at the end of work

Printer maintenance

Replacing consumable parts

When not using the printer for a long period of time

Moving or transporting the printer

When an ink cartridge (ink bag) is nearing replacement

When the ink level becomes low, the status light on the printer control panel blinks in red with beep sound.

1 Tap  [Enter] key.

- The beep sound stops.
- The printer status and an ink level warning message appear alternately at two seconds interval. The ink level indicator of the ink cartridge (ink bag) appears or disappears at 0.5 seconds interval.
- In the figure to the right, the slot2 and slot4 ink bag is nearing replacement.

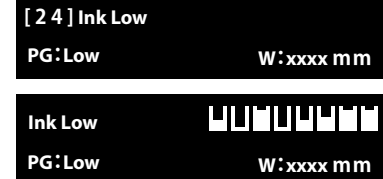

2 Prepare the replacement ink cartridge (ink bag).

 ["Replacing with a new ink" P. 160](#)

Note

If it happens during sleep mode, the printer continues in sleep mode after the beep sound stops.

Before Use

Basic Operations

Various Settings

Maintenance

When problems occur

Appendix

About Maintenance

Wearing protective equipment

Agitating ink

Checking ink level and replacing cartridge

Emptying waste ink tank

Daily maintenance at the end of work

Printer maintenance

Replacing consumable parts

When not using the printer for a long period of time

Moving or transporting the printer

Replacing with a new ink

When an ink cartridge (ink bag) runs out of ink, the error message [Ink End] appears on the panel with blinking error LED and beep sound. Replace with a new ink cartridge (ink bag) and a new smart chip card immediately. The printer will not resume printing until it is replaced.



Warning



Keep ink cartridge or ink bag away from fire or heat source to avoid risk of fire.



Caution



If UV inks or waste fluids come in contact with skin or eyes, it may induce allergic reaction or inflammation. When you do this operation, always wear protective gloves (such as solvent-resistant gloves) and goggles to avoid contact with skin or eyes.

Important !!

- Do not replace ink cartridge (ink bag) when the printer is powered off. Ink level cannot be detected correctly.
- When moving an ink cartridge (ink bag) from cold place to warm place, rest it in room temperature at least 3 hours before use.
- If you do not have a new ink cartridge (ink bag) for replacement, leave the old one installed. This may cause the nozzle clogs.

Before Use

Basic Operations

Various Settings

Maintenance

When problems occur

Appendix

About Maintenance

Wearing protective equipment

Agitating ink

Checking ink level and replacing cartridge

Emptying waste ink tank

Daily maintenance at the end of work

Printer maintenance

Replacing consumable parts

When not using the printer for a long period of time

Moving or transporting the printer

When using ink cartridges

- 1 Tap  [Enter] key on the printer control panel.
 - The beep sound stops.
 - In this illustration, the ink cartridges in slots 1 and 8 need replacement.

Ink End



- 2 Remove the ink cartridge from the ink slot.

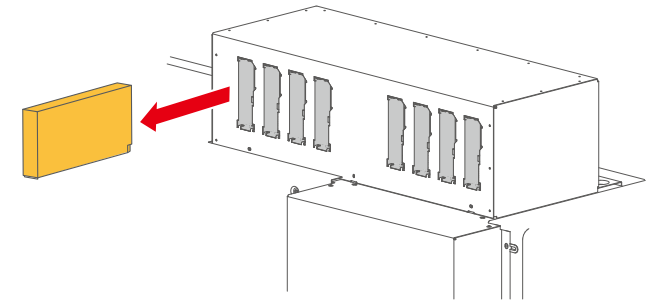

- 3 Prepare a new ink cartridge and follow the instructions below to agitate ink.

- Hold the ink cartridge with the ink outlet facing up and wait for three seconds.
- Invert it so that the ink outlet is facing down and wait for three seconds.
- Repeat this ten times (*white ink: twenty times).

 **Note**

There is no need to agitate varnish ink.

3 sec.



3 sec.

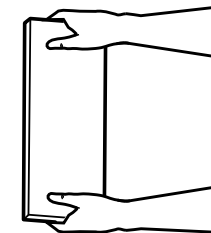

x 10

Before Use

Basic Operations

Various Settings

Maintenance

When problems occur

Appendix

About Maintenance

Wearing protective equipment

Agitating ink

Checking ink level and replacing cartridge

Emptying waste ink tank

Daily maintenance at the end of work

Printer maintenance

Replacing consumable parts

When not using the printer for a long period of time

Moving or transporting the printer

4

Insert the new ink cartridge into the ink slot.

- Make sure to match the color of the ink cartridge with the color of the label attached to the ink slot (This illustration is an example of 4-color configuration).
- Face the arrow mark upward.
- Insert it all the way in so that it is correctly seated.

Important !!

Make sure you insert it in the original ink slot. Do not insert in a different ink slot even if it is the same color.

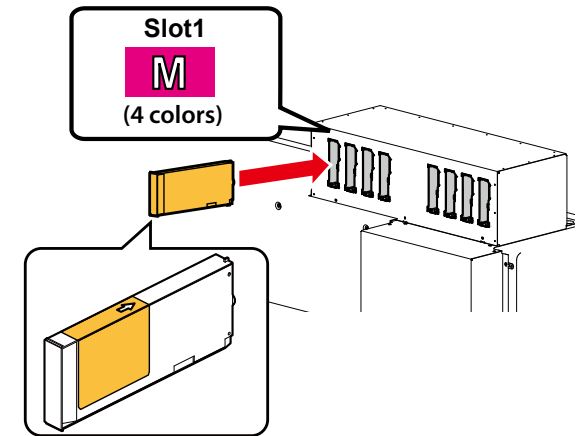

When using ink bags with high-capacity ink pack adapters

1. Remove the high-capacity ink pack adapter

1

Tap  [Enter] key on the printer control panel.

- The beep sound stops.
- In this illustration, the ink bags in the slots 1 and 8 need replacement.

Ink End



2

Remove the high-capacity ink pack adapter of the ink bag to be replaced.

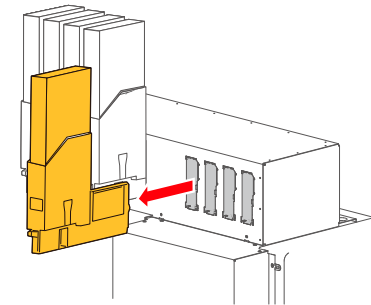

Before Use

About Maintenance

Basic Operations

Wearing protective equipment

Various Settings

Agitating ink

Maintenance

Checking ink level and replacing cartridge

When problems occur

Emptying waste ink tank

Appendix

Daily maintenance at the end of work

Printer maintenance

Replacing consumable parts

When not using the printer for a long period of time

Moving or transporting the printer

3 Remove the light-blocking cover.

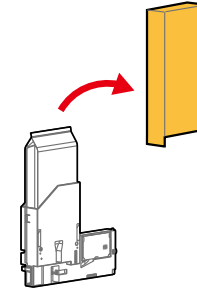

4 Remove the empty ink bag while lowering the lock lever on the high-capacity ink pack adapter.

Note

Put the empty ink bag in a plastic bag and dispose of it according to the local regulations.

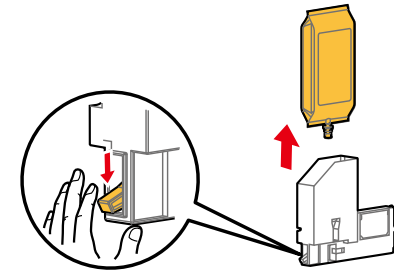

5 Remove the smartchip card from the high-capacity ink pack adapter.

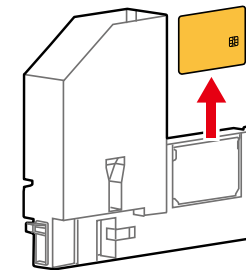

Before Use

Basic Operations

Various Settings

Maintenance

When problems occur

Appendix

About Maintenance

Wearing protective equipment

Agitating ink

Checking ink level and replacing cartridge

Emptying waste ink tank

Daily maintenance at the end of work

Printer maintenance

Replacing consumable parts

When not using the printer for a long period of time

Moving or transporting the printer

2. Load a new ink bag

- 1 Prepare a new ink bag and follow the instructions below to agitate ink.
 - Hold the ink bag with the ink outlet facing up and wait for three seconds.
 - Invert it so that the ink outlet is facing down and wait for three seconds.
 - Repeat this ten times (white ink : twenty times).

Note

There is no need to agitate varnish ink.

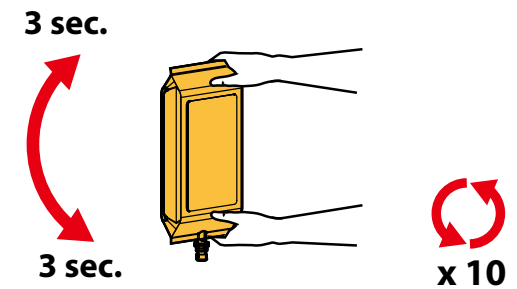

- 2 Insert the new smartchip card into the card slot on the high-capacity ink pack adapter.

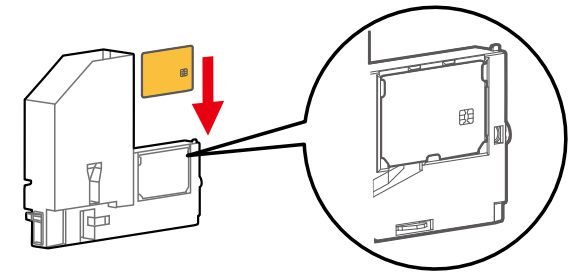

- 3 Insert the new ink bag while lowering the lock lever on the high-capacity ink pack adapter.
 - Insert the ink bag all the way in to seat properly.

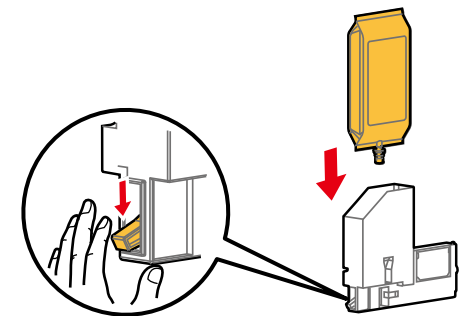

Before Use

Basic Operations

Various Settings

Maintenance

When problems occur

Appendix

About Maintenance

Wearing protective equipment

Agitating ink

Checking ink level and replacing cartridge

Emptying waste ink tank

Daily maintenance at the end of work

Printer maintenance

Replacing consumable parts

When not using the printer for a long period of time

Moving or transporting the printer

4 Ensure that the ink bag is fully seated and locked.

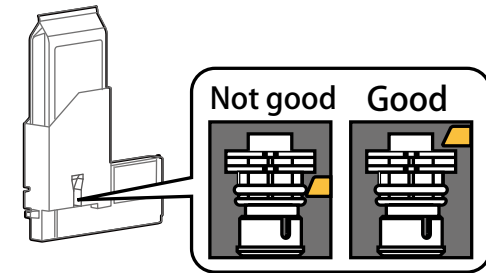

5 Check that the lock lever of the high-capacity ink pack adapter is back to its original position.

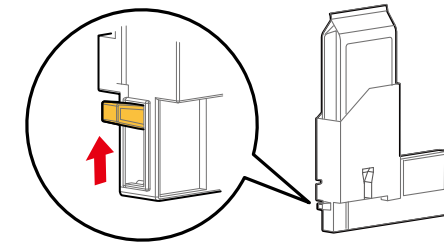

6 Cover the ink bag with the light-blocking cover.

Note

Attach it so that the light-blocking cover comes inside the high-capacity ink pack adapter.

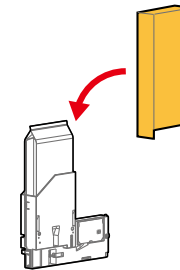

7 Insert the high-capacity ink pack adapter into the ink slot.

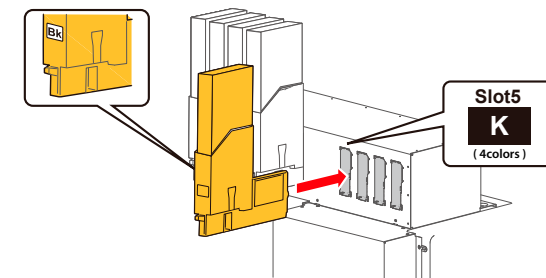

- Make sure to match the color of the ink bag with the color of the label attached to each ink slot (This illustration is an example of 4-color configuration).
- Insert it all the way in so that it is correctly seated.



Before Use	About Maintenance
Basic Operations	Wearing protective equipment
Various Settings	Agitating ink
Maintenance	Checking ink level and replacing cartridge
When problems occur	Emptying waste ink tank
Appendix	Daily maintenance at the end of work
	Printer maintenance
	Replacing consumable parts
	When not using the printer for a long period of time
	Moving or transporting the printer

Replace the adapter's plug for high-capacity ink pack adapter

When the life of the plug ends, the message will appear. Follow these steps to replace with a new plug.

- 1 When [[1] Change Plug OK -> Enter] appears, tap  [Enter] key.
 - The number in parentheses identifies the slot number.
- 2 The message [[1] Change Plug] appears.
- 3 Follow the instructions in the high-capacity ink pack adapter's operation manual to replace with a new plug.
 - 👉 [High-capacity Ink Pack Adapter Operation Manual "3.3 Replacing Adapter's Plug"](#)
- 4 When you inserted the high-capacity ink pack adapter into the ink slot after replacement, the message [[1] Plug Changed? No] appears.
 - Tap  key.
- 5 The message [[1] Plug Changed? Yes] appears.
 - Tap  [Enter] key.
 - The lifetime counter of the adapter's plug will be reset.

Important /

If you do not replace the plug, do not choose "Yes". Using the high-capacity ink pack adapter without replacing the plug can cause ink leakage.

Before Use

Basic Operations

Various Settings

Maintenance

When problems occur

Appendix

About Maintenance

Wearing protective equipment

Agitating ink

Checking ink level and replacing cartridge

Emptying waste ink tank

Daily maintenance at the end of work

Printer maintenance

Replacing consumable parts

When not using the printer for a long period of time

Moving or transporting the printer

Emptying waste ink tank

In the following cases, drain waste fluids into a container to empty the waste ink tank:

- When the waste ink tank is more than half full
- When the message [Empty Waste Ink Tank then Tap Enter] appears
- When the message [Full WasteInkTank] appears

Warning message

Empty Waste Ink Tank
then Tap Enter

Appears periodically. Empty the waste ink tank.

- After emptying the tank, tap  [Enter] key so that the display returns to the previous menu.

Full WasteInkTank

The waste fluid tank has become full. Empty the waste ink tank immediately.

- Printing or other operation will stop. It will resume when you have emptied the tank.



Warning



- Keep out of direct sunlight and store the waste ink container in a cool, dark place.
- Keep away waste fluid from fire and high temperatures.
- Do not mix waste ink with any other chemical substances, not even in small amounts.



- When mixed with other chemicals (e.g. oxidants), heating may occur.
- Use a HDPE container with light blocking properties to store waste liquid.
- When storing for a long time, slightly loosen the cap on the container to allow air. Do not tightly close it.



Caution



- Skin or eye contact with UV curable ink may cause skin inflammation or allergic reaction.
- For this operation, be sure to wear the supplied gloves (or solvent resistant gloves) and goggles to prevent ink from contacting with your eyes or skin.

Before Use

Basic Operations

Various Settings

Maintenance

When problems occur

Appendix

About Maintenance

Wearing protective equipment

Agitating ink

Checking ink level and replacing cartridge

Emptying waste ink tank

Daily maintenance at the end of work

Printer maintenance

Replacing consumable parts

When not using the printer for a long period of time

Moving or transporting the printer

Procedure

- 1 Prepare a container to collect waste fluids.

Important !!

The capacity of waste fluid tank is 2,000 ml. Make sure to prepare a container that has enough capacity.

Note

If no or small amount of waste fluid is collected in the waste ink tank, you may not be able to drain fluid out of the tank.

- 2 Cover the floor under the waste ink tank with waste paper or cloth.

- 3
 - Wear the rubber gloves over the polyethylene gloves.
 - Wear protective equipment such as goggle, protective mask, protective clothing.

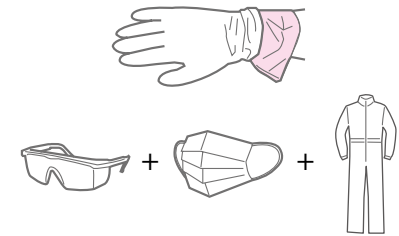

- 4 Open the cover of the waste ink valve case, then take the drain tube valve out from the case.

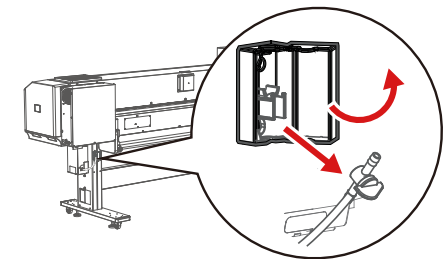

Before Use

About Maintenance

Basic Operations

Wearing protective equipment

Various Settings

Agitating ink

Maintenance

Checking ink level and replacing cartridge

When problems occur

Emptying waste ink tank

Appendix

Daily maintenance at the end of work

Printer maintenance

Replacing consumable parts

When not using the printer for a long period of time

Moving or transporting the printer

- Put the tip of the drain tube valve in the empty container and open the valve to drain waste ink from the waste ink tank.

Note

Waste ink may splash while draining from the waste ink tank.
Make sure to put the tip of the drain tube valve in the empty container to prevent splash.

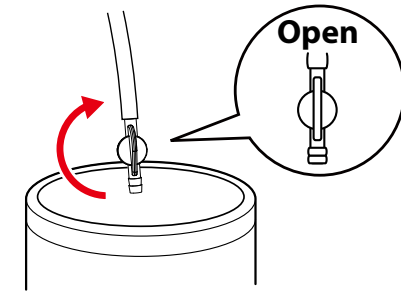

- Once you finish emptying the waste ink tank, close the drain tube valve firmly.

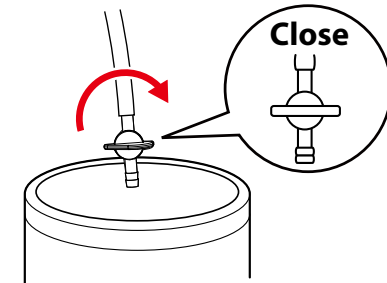

- Use a dry cloth to clean the tip of the valve.

- Hook the drain tube valve on the clamp of the waste ink valve case, then close the cover.

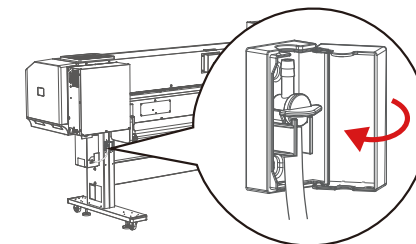

Before Use	About Maintenance
Basic Operations	Wearing protective equipment
Various Settings	Agitating ink
Maintenance	Checking ink level and replacing cartridge
When problems occur	Emptying waste ink tank
Appendix	Daily maintenance at the end of work
	Printer maintenance
	Replacing consumable parts
	When not using the printer for a long period of time
	Moving or transporting the printer

9 Dispose of the waste fluid as an industrial waste product.



Warning



- You are obligated to properly dispose of waste fluid from the printer in compliance with Wastes Disposal and Public Cleansing Act and local ordinances. Delegate disposal to an industrial waste disposal contractor.
- Waste fluid from this printer is harmful to aquatic organisms. Do not allow it to reach sewage or natural water systems.

10 When [Empty Waste Ink Tank then Tap Enter] was displayed:

- After emptying the tank, tap  [Enter] key.
- The display will return to the previous menu.



When [Full Waste Ink Tank] was displayed:

- After emptying the tank, the printer will resume operation.

Before Use	About Maintenance
Basic Operations	Wearing protective equipment
Various Settings	Agitating ink
Maintenance	Checking ink level and replacing cartridge
When problems occur	Emptying waste ink tank
Appendix	Daily maintenance at the end of work
	Printer maintenance
	Replacing consumable parts
	When not using the printer for a long period of time
	Moving or transporting the printer

Daily maintenance at the end of work

! Make sure to read the following sections before this task.

-  "Handling" P. 12
-  "Ink and waste fluid" P. 14

This printer requires daily maintenance. Follow these steps to perform a daily maintenance when you are done the printing for the day.

Step 1. Preparations for maintenance

Step 2. Putting the printer into Sleep mode

Step 3. Perform a daily maintenance

1. Cleaning of the UV-LED lamp on the left side
2. Cleaning of the parts around the print head
3. Cleaning of the cleaning wiper and the parts around the capping unit
4. Cleaning of the UV-LED lamp on the right side

Step 4. Ending the daily maintenance

Important!

- Even when you are printing all day long without entering to sleep mode, make sure to perform a daily maintenance once a day. Failure to do so could cause print defects or printer failure. To perform a daily maintenance without entering to sleep mode or powering off, go to [Maintenance10: Daily Maintenance].
-  "Cleaning each part of the printer" P. 189
- Make sure to perform a daily maintenance in the correct order.

Before Use

Basic Operations

Various Settings

Maintenance

When problems occur

Appendix

About Maintenance

Wearing protective equipment

Agitating ink

Checking ink level and replacing cartridge

Emptying waste ink tank

Daily maintenance at the end of work

Printer maintenance

Replacing consumable parts

When not using the printer for a long period of time

Moving or transporting the printer

Step 1. Preparations for maintenance

What you need

1 Prepare the following items for maintenance.



polyethylene gloves



rubber gloves



protective goggles

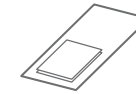

paper towel or polyester knit wiper



dropper



protective mask



designated maintenance cleaner



plastic cup

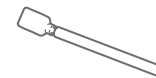

cleaning stick



tray



scraper



protective clothing

Important!

- Use a paper towel supplied with the printer or optional polyester knit wiper.
- Do not use a tissue. Lint or flakes on tissue may cause damage to the print head.
- Do not use non-designated maintenance cleaner.
- To purchase the optional accessories such as designated maintenance cleaner, contact your local MUTOH dealer

2 • Wear the rubber gloves over the polyethylene gloves.
• Wear protective equipment such as goggle, protective mask, protective clothing.

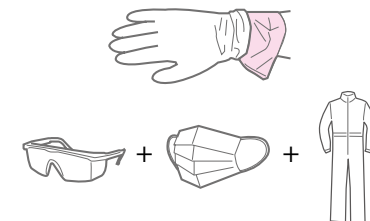

Before Use

Basic Operations

Various Settings

Maintenance

When problems occur

Appendix

About Maintenance

Wearing protective equipment

Agitating ink

Checking ink level and replacing cartridge

Emptying waste ink tank

Daily maintenance at the end of work

Printer maintenance

Replacing consumable parts

When not using the printer for a long period of time

Moving or transporting the printer

Step 2. Putting the printer into Sleep mode



 ["Sleep Mode" P.103](#)

- 1 Check that
 - the front cover and the maintenance covers are closed.
 - media is removed from the printer.
 - ink cartridges (ink bags) have sufficient ink.
 - the waste ink tank has enough space.

Important !!

If you are going to leave the printer in sleep mode for a long period of time, empty the waste ink tank once a week:

 ["Emptying waste ink tank" P.167](#)

- 2 Go to the "Sleep Mode" menu.
 - Tap  [Home] key so that [Menu1 Setup] appears.
 - Use  key to choose [Menu8 Sleep Mode].
 - Tap  key.

- 3 When [Sleep Mode1 Start] appears, tap  key.

- 4 When [Sleep Mode Start -> Enter] appears, tap  [Enter] key.

- 5 When [Daily Maintenance Start -> Enter] appears, tap  [Enter] key.
 - [Please Wait] appears.
 - The carriage will move to the maintenance position.

- 6 When this message appears on the control panel, start performing a daily maintenance.

 ["Step 3. Perform a daily maintenance" P. 174](#)

- Do not tap the  [Enter] key. This will exit the maintenance state.

Daily Maintenance
Next -> Enter

Before Use

Basic Operations

Various Settings

Maintenance

When problems occur

Appendix

About Maintenance

Wearing protective equipment

Agitating ink

Checking ink level and replacing cartridge

Emptying waste ink tank

Daily maintenance at the end of work

Printer maintenance

Replacing consumable parts

When not using the printer for a long period of time

Moving or transporting the printer

Step 3. Perform a daily maintenance

 **Important !**

Make sure to complete this maintenance within 5 minutes while the printer is in Daily maintenance state.

1. Cleaning of the UV-LED lamp on the left side

 **Caution**



The UV-LED lamp may get hot after printing.

Allow the lamp to cool down for 10 minutes after printing and then start maintenance.

1 Slowly open the covers in the following order:

- ① Front cover
- ② Maintenance cover L

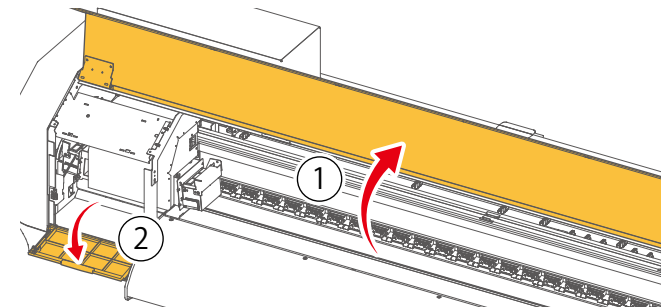

2 Look at the glass attached on the bottom surface of the UV-LED lamp on the left side and check if ink is on the glass.

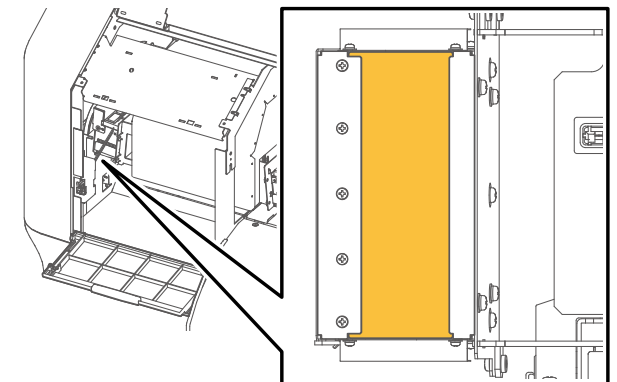

Before Use

Basic Operations

Various Settings

Maintenance

When problems occur

Appendix

About Maintenance

Wearing protective equipment

Agitating ink

Checking ink level and replacing cartridge

Emptying waste ink tank

Daily maintenance at the end of work

Printer maintenance

Replacing consumable parts

When not using the printer for a long period of time

Moving or transporting the printer

3 If ink is on the glass, follow these steps to clean it.

1. Slide up the left side of the exhaust fan cover using the right side screw serves as a fulcrum.
2. Slide the glass attached on the bottom of the lamp towards the front to remove it.
3. Press the scraper on the ink deposits with a slight angle and scrape it off.
4. Use the paper towel to clean the ink scraped from the glass.
5. Put the glass back on the lamp.
6. Firmly slide it into the end and then put the exhaust fan cover back in place.

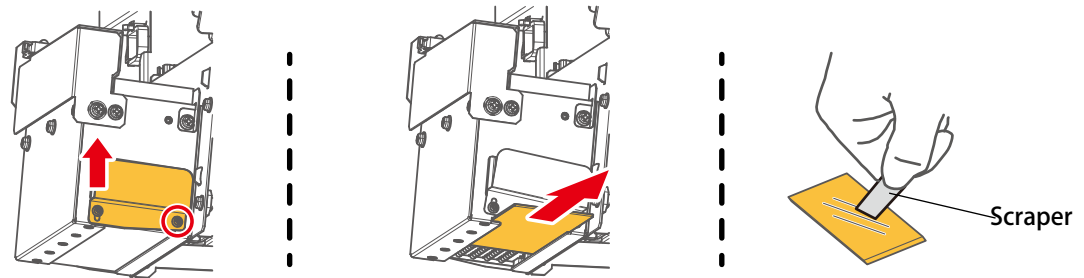

Important !

- Make sure to use the scraper supplied with the printer.
- Do not press the edge of the scraper too hard. This will cause damage to the glass
- Make sure that the emitting window glass is attached to the lamp and the exhaust fan cover is put back in place. Using your printer without them will cause damage to the lamp.

4 Next moisten the surface of print head nozzles. ☞ "2. Cleaning of the parts around the print head" P. 176

Before Use

Basic Operations

Various Settings

Maintenance

When problems occur

Appendix

About Maintenance

Wearing protective equipment

Agitating ink

Checking ink level and replacing cartridge

Emptying waste ink tank

Daily maintenance at the end of work

Printer maintenance

Replacing consumable parts

When not using the printer for a long period of time

Moving or transporting the printer

2. Cleaning of the parts around the print head

Important!

- Be sure to follow the instructions as indicated.
- Always use a new cleaning stick and designated maintenance cleaner. Reusing cleaning sticks or using non-designated cleaner may damage the print head.
- Do not touch the tip of the cleaning stick with your finger. If sebum or other contaminants get on the stick, it will damage the print head.
- To avoid making a mess inside of the printer, place the tray under the carriage.
- Do not leave the tray under the carriage. Leaving it for a long time could cause the ink to cure on the nozzle surface of the print head due to reflection of ambient light.

- 1** Soak the cleaning stick in the designated maintenance cleaner.
 1. Put a new cleaning stick in a plastic cup.
 2. Use the dropper to drop the designated maintenance cleaner on the tip of the cleaning stick. (Use about 0.5 ml)



- 2** Place the tray under the carriage.

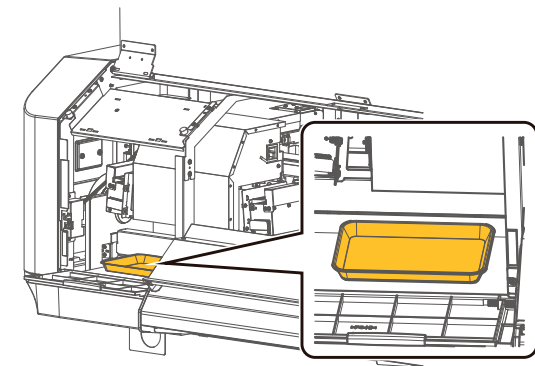

Before Use

Basic Operations

Various Settings

Maintenance

When problems occur

Appendix

About Maintenance

Wearing protective equipment

Agitating ink

Checking ink level and replacing cartridge

Emptying waste ink tank

Daily maintenance at the end of work

Printer maintenance

Replacing consumable parts

When not using the printer for a long period of time

Moving or transporting the printer

- 3** Wipe off ink and dust adhering to the parts around the print head on the bottom of the carriage with a cleaning stick.

 Clean this part.

 Never touch the nozzle surface.

- The parts around the print head (metal parts)

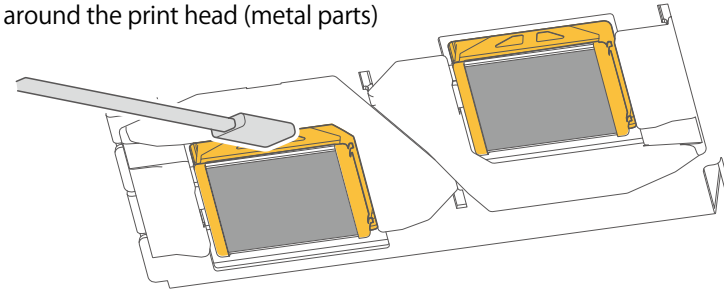

- Print head guide (black plastic parts)

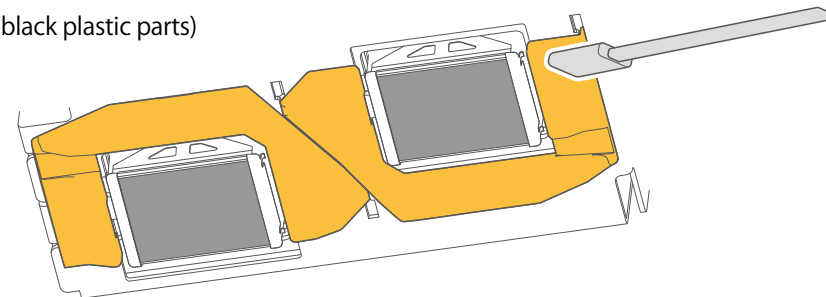

 **Important !**

- Do not leave the tray under the carriage. Leaving it for a long time could cause the ink to cure on the nozzle surface of the print head due to reflection of ambient light.
- If maintenance cleaner gets on the printer, wipe it off with a paper towel.

Before Use

About Maintenance

Basic Operations

Wearing protective equipment

Various Settings

Agitating ink

Maintenance

Checking ink level and replacing cartridge

When problems occur

Emptying waste ink tank

Appendix

Daily maintenance at the end of work

Printer maintenance

Replacing consumable parts

When not using the printer for a long period of time

Moving or transporting the printer

4 Remove the tray.

Important !

Do not leave the tray under the carriage. Leaving it for a long time could cause the ink to cure on the nozzle surface of the print head due to reflection of ambient light.

5 Slowly close the maintenance cover L.

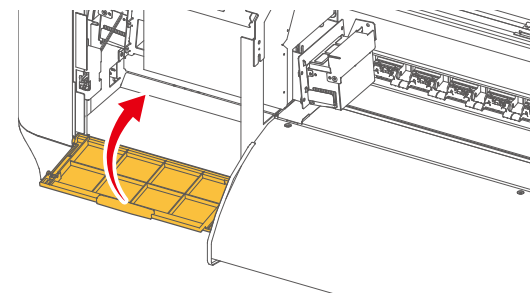

6 Next clean the cleaning wiper and the parts around the capping unit

👉 ["3. Cleaning of the cleaning wiper and the parts around the capping unit" P. 179](#)

Important !

If the cleaning stick becomes dirty, submerge the foam tip of the stick into the maintenance cleaner in the plastic cup to clean it. If the dirt does not get off, replace it with a new cleaning stick.

Before Use

Basic Operations

Various Settings

Maintenance

When problems occur

Appendix

About Maintenance

Wearing protective equipment

Agitating ink

Checking ink level and replacing cartridge

Emptying waste ink tank

Daily maintenance at the end of work

Printer maintenance

Replacing consumable parts

When not using the printer for a long period of time

Moving or transporting the printer

3. Cleaning of the cleaning wiper and the parts around the capping unit

1 Slowly open the maintenance cover R.

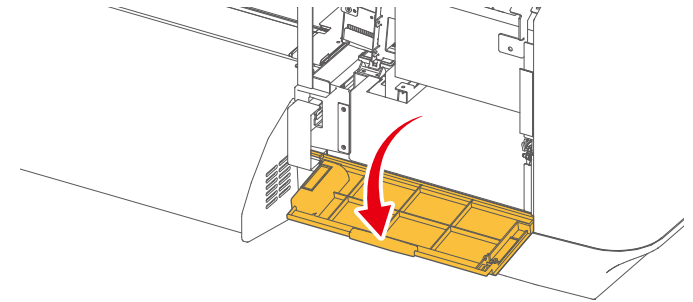

2 Press the area shown in red in the illustration to raise the wiper.

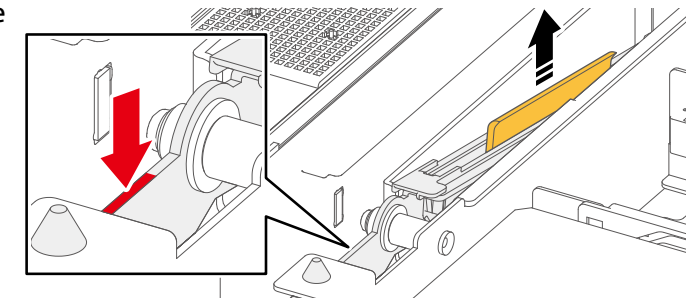

3 Wipe off ink and dust on the cleaning wiper (black rubber part) with a cleaning stick.

- Clean both left and right sides of the wiper.

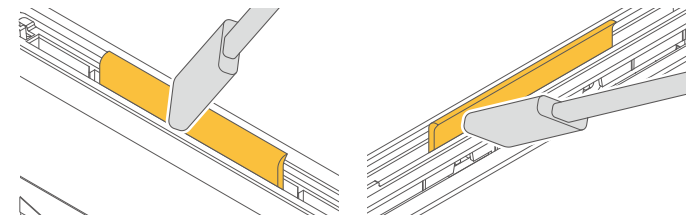

Before Use

Basic Operations

Various Settings

Maintenance

When problems occur

Appendix

About Maintenance

Wearing protective equipment

Agitating ink

Checking ink level and replacing cartridge

Emptying waste ink tank

Daily maintenance at the end of work

Printer maintenance

Replacing consumable parts

When not using the printer for a long period of time

Moving or transporting the printer

- 4 Use the cleaning stick to clean the parts around the capping unit to wipe off ink and dust.

 Clean this part  Never touch the absorber.

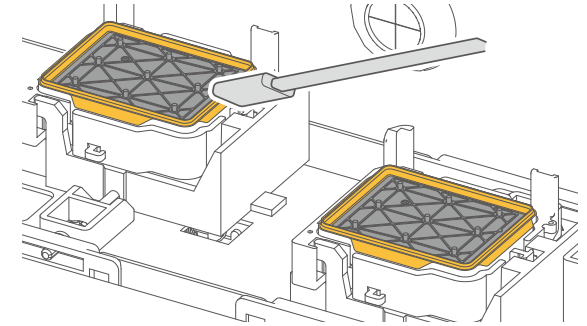

- 5 Slowly close the covers in the following order:
- ① Maintenance cover R
 - ② Front cover

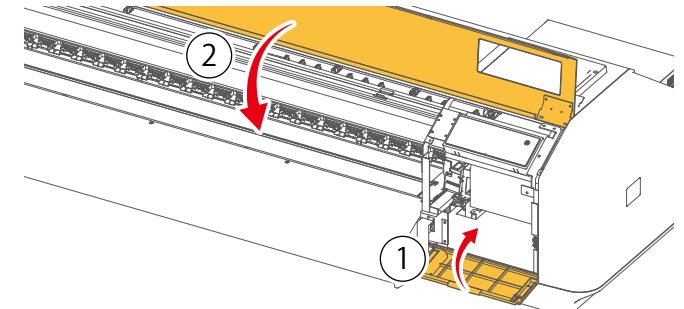

- 6 Tap  [Enter] key.
- The carriage moves to the position to clean the right UV-LED lamp.

Daily Maintenance
Next → Enter

- 7 Next Clean the UV-LED lamp on the right side.
 "4. Cleaning of the UV-LED lamp on the right side" P. 181

Before Use

Basic Operations

Various Settings

Maintenance

When problems occur

Appendix

About Maintenance

Wearing protective equipment

Agitating ink

Checking ink level and replacing cartridge

Emptying waste ink tank

Daily maintenance at the end of work

Printer maintenance

Replacing consumable parts

When not using the printer for a long period of time

Moving or transporting the printer

4. Cleaning of the UV-LED lamp on the right side

Caution



The UV-LED lamp may get hot after printing.

Allow the lamp to cool down for 10 minutes after printing and then start maintenance.

1 When this message appears on the control panel, start cleaning the right UV-LED lamp.

- Do not tap the  [Enter] key. This will exit the maintenance state.

Check UV LampR

End



Enter

2 Slowly open the covers in the following order:

- ① Front cover
- ② Maintenance cover R

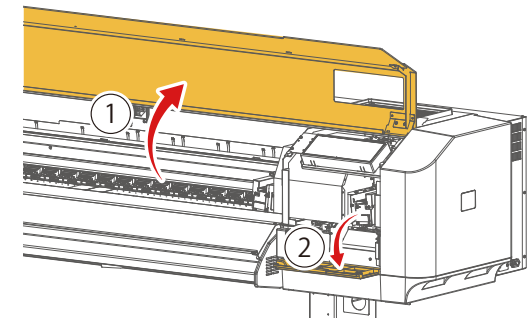

3 Look at the glass attached on the bottom surface of the UV-LED lamp on the right side and check if ink is on the glass.

Note

The carriage can be moved by hand. Move the carriage slowly to the position you can check the glass on the bottom and check it.

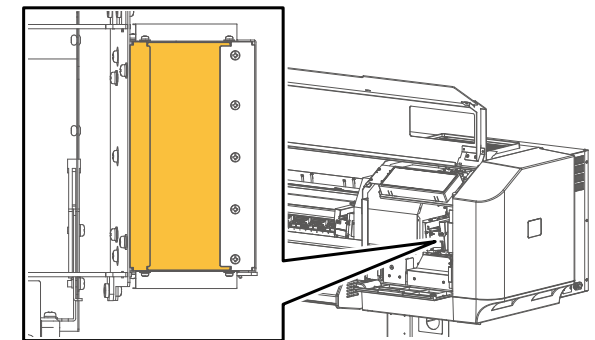

Before Use

About Maintenance

Basic Operations

Wearing protective equipment

Various Settings

Agitating ink

Maintenance

Checking ink level and replacing cartridge

When problems occur

Emptying waste ink tank

Appendix

Daily maintenance at the end of work

Printer maintenance

Replacing consumable parts

When not using the printer for a long period of time

Moving or transporting the printer

4 If ink is on the glass, follow the steps described in [“1. Cleaning of the UV-LED lamp on the left side” P. 174](#) to clean it.

5 Slowly close the covers in the following order:

- ① Maintenance cover R
- ② Front cover

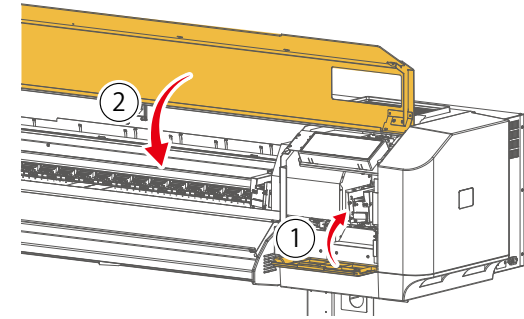

6 Next end the daily maintenance.
👉 [“Step 4. Ending the daily maintenance” P. 183](#)

Before Use

Basic Operations

Various Settings

Maintenance

When problems occur

Appendix

About Maintenance

Wearing protective equipment

Agitating ink

Checking ink level and replacing cartridge

Emptying waste ink tank

Daily maintenance at the end of work

Printer maintenance

Replacing consumable parts

When not using the printer for a long period of time

Moving or transporting the printer

Step 4. Ending the daily maintenance

- 1 Tap  [Enter] key on the printer control panel.
 - The printer automatically performs a cleaning.



Check UV LampR
End -> Enter

Note

If you accessed from the [Daily Maintenance] menu, the display returns to the menu selection.

 ["Daily Maintenance" P. 127](#)

- 2 Once the cleaning is complete, the message on the right will appear on the panel.
 - The printer is put into sleep mode.

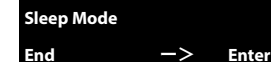

Sleep Mode
End -> Enter

Note



• While in sleep mode, the LED above the Power button blinks every five seconds.

- 3 End the daily maintenance.
 - Please dispose of the cleaning stick. Cleaning stick is not reusable.
 - Wipe off the maintenance cleaner on the dropper and tray with a paper towel.
 - Dispose of the maintenance cleaner in the plastic cup and dry the cup well using the paper towel.

Important!

• Check that the lid of the maintenance cleaner is shut properly and store it.
• Used cleaning stick and the maintenance cleaner left in the plastic cup are industrial waste. Dispose of them in accordance with the local regulations.

Before Use	About Maintenance
Basic Operations	Wearing protective equipment
Various Settings	Agitating ink
Maintenance	Checking ink level and replacing cartridge
When problems occur	Emptying waste ink tank
Appendix	Daily maintenance at the end of work
	Printer maintenance
	Replacing consumable parts
	When not using the printer for a long period of time
	Moving or transporting the printer

4 To wake up from sleep mode, tap  [Enter] key.
 ["To wake up from sleep mode" P. 104](#)

Before Use

Basic Operations

Various Settings

Maintenance

When problems occur

Appendix

About Maintenance

Wearing protective equipment

Agitating ink

Checking ink level and replacing cartridge

Emptying waste ink tank

Daily maintenance at the end of work

Printer maintenance

Replacing consumable parts

When not using the printer for a long period of time

Moving or transporting the printer

Printer maintenance

Head cleaning

If there are missing lines in the nozzle check print, perform a head cleaning.

- **“Run a nozzle check” P. 61**

Print a nozzle check pattern to see if all nozzles properly fire ink.

- **“Perform a head cleaning” P. 65**

If nozzle clogs, perform a head cleaning.

There are several cleaning modes available in this product. Select an appropriate mode depending on the nozzle check result.

If nozzle clogging still persists after head cleaning attempt, perform a soak cleaning.

 **“Soak Cleaning” P. 186**

Before Use

Basic Operations

Various Settings

Maintenance

When problems occur

Appendix

About Maintenance

Wearing protective equipment

Agitating ink

Checking ink level and replacing cartridge

Emptying waste ink tank

Daily maintenance at the end of work

Printer maintenance

Replacing consumable parts

When not using the printer for a long period of time

Moving or transporting the printer

Soak Cleaning

When to perform:

- once a week(recommended)
- nozzle clogging or nozzle deflection persists after cleaning attempt.

Preparation:

- Polyethylene gloves, rubber gloves, protective eye wear, mask
- Plastic cup, Dropper
- Designated maintenance cleaner,

1 Wear protective equipment.
👉 [“Wearing protective equipment” P. 144](#)

2 Pour an appropriate amount of maintenance cleaner into the plastic cup.



3 Go to the “Soak Cleaning” menu.

- Tap [Home] key so that [Menu1 Setup] appears.
- Use key to choose [Menu3 Maintenance].
- Tap key [Maintenance1: Cleaning] appears.
- Use / key to choose [Maintenance5: Soak Cleaning].

4 Tap key.

- [Soak Cleaning /Start ->Enter] appears.

Before Use

Basic Operations

Various Settings

Maintenance

When problems occur

Appendix

About Maintenance

Wearing protective equipment

Agitating ink

Checking ink level and replacing cartridge

Emptying waste ink tank

Daily maintenance at the end of work

Printer maintenance

Replacing consumable parts

When not using the printer for a long period of time

Moving or transporting the printer

5 Tap  [Enter] key.

- The carriage moves to the maintenance position (left side of the printer).

6 When [Pour Cleaning Fluid/ End -> Enter] appears, start maintenance.

Slowly open the covers in the following order:

- ① Front cover
- ② Maintenance cover R

 **Note**

The message "Close cover" appears if the covers are open for more than ten minutes. In such cases, close all the covers and start again.

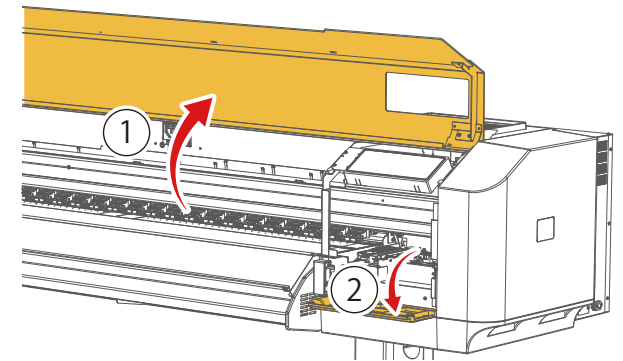

7 Fill the head cap with maintenance cleaner.

- Use a dropper to fill it with maintenance cleaner until the cleaner almost overflows the cap.

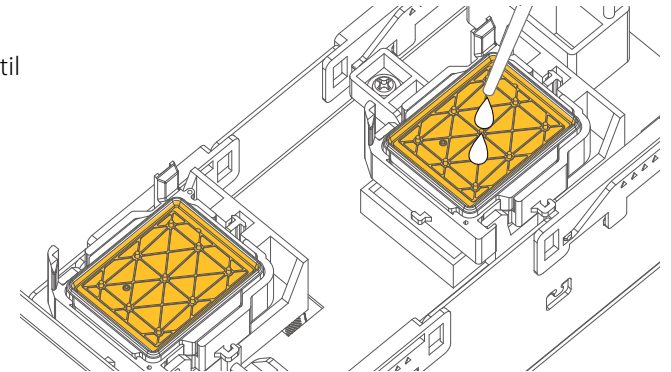

Before Use

Basic Operations

Various Settings

Maintenance

When problems occur

Appendix

About Maintenance

Wearing protective equipment

Agitating ink

Checking ink level and replacing cartridge

Emptying waste ink tank

Daily maintenance at the end of work

Printer maintenance

Replacing consumable parts



When not using the printer for a long period of time

Moving or transporting the printer

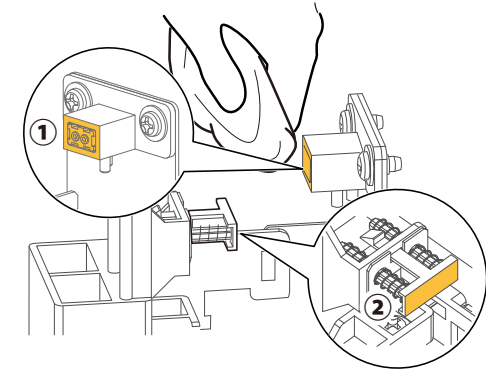
- 8 Using a paper towel, completely wipe off any ink on the surface of the air valve (parts ① and ②).



- 9 Slowly close the maintenance cover R and then the front cover in order. Tap  [Enter] key.
- The carriage goes back to the capping station.

- 10 When [Soaking time: (1-99) 10 min] appears, use  /  key to specify the soaking time and then tap  [Enter] key.
- The countdown begins.
 - 10 minutes is recommended for soak cleaning time.

- 11 When the timer reaches 0, the cleaning begins automatically.

- 12 End the soak cleaning.
- Clean off the maintenance cleaner from the dropper with the paper towel.
 - Dispose of the maintenance cleaner in the plastic cup and clean off the cup with the paper towel.

 **Important !**

- Close the maintenance cleaner bottle tightly and store it.
- Used paper towel and the maintenance cleaner left in the plastic cup are industrial waste. Dispose of them in accordance with the local regulations.

Before Use

Basic Operations

Various Settings

Maintenance

When problems occur

Appendix

About Maintenance

Wearing protective equipment

Agitating ink

Checking ink level and replacing cartridge

Emptying waste ink tank

Daily maintenance at the end of work

Printer maintenance

Replacing consumable parts

When not using the printer for a long period of time

Moving or transporting the printer

Cleaning each part of the printer

You will need to clean each part of the printer when

- lines are blurred or image is partially not printed even after head cleaning was performed
- ink smudge appears.

☞ ["Cleaning flow" P. 189](#)

- Automatic print head alignment or print quality calibration failed repeatedly

☞ ["Cleaning the color sensor" P. 191](#)

- Once a month
- you see ink dirt or dust on the printer.

☞ ["Cleaning inside the printer" P. 193](#)

Cleaning flow

Important!

Use this procedure when you want to continue to use your printer after the maintenance.

When you perform a daily maintenance at the end of the work, put the printer into sleep mode and perform a daily maintenance.

☞ ["Daily maintenance at the end of work" P. 171](#)

1. Put the printer in daily maintenance state.

1 Prepare necessary items for a daily maintenance.

☞ ["Step 1. Preparations for maintenance" P. 172](#)

Before Use	About Maintenance
Basic Operations	Wearing protective equipment
Various Settings	Agitating ink
Maintenance	Checking ink level and replacing cartridge
When problems occur	Emptying waste ink tank
Appendix	Daily maintenance at the end of work
	Printer maintenance
	Replacing consumable parts
	When not using the printer for a long period of time
	Moving or transporting the printer

- Go to the "Daily Maintenance" menu.
 - Tap [Home] key. [Menu1 Setup] appears.
 - Tap key several times to select [Menu 3 Maintenance].
 - Tap key. [Maintenance1 Cleaning] appears.
 - Tap / key several times to select [Maintenance5 Daily Maintenance].

- Tap key and when [Daily Maintenance Start -> Enter] appears.
 - Tap [Enter] key.

- The message [Please Wait] appears.
 - The carriage will move to the maintenance position (left side of the printer).

- [Daily Maintenance next -> Enter] appears.

2. Cleaning each part of the printer

Clean the following parts. Follow the instructions of Daily Maintenance to clean.

- ["2. Cleaning of the parts around the print head" P. 176](#)
- ["3. Cleaning of the cleaning wiper and the parts around the capping unit" P. 179](#)

Before Use

Basic Operations

Various Settings

Maintenance

When problems occur

Appendix

About Maintenance

Wearing protective equipment

Agitating ink

Checking ink level and replacing cartridge

Emptying waste ink tank

Daily maintenance at the end of work

Printer maintenance

Replacing consumable parts

When not using the printer for a long period of time

Moving or transporting the printer

Cleaning the color sensor

Preparation:

- Polyethylene gloves, rubber gloves, protective eye wear, mask
- cleaning stick
- ethanol (more than 50% ethanol)

Important !!

- Do not push hard on the color sensor glass with cleaning stick. This will cause damage to the glass.
- Do not reuse the cleaning stick. This will cause dust to adhere to the sensor, leading to malfunction.
- The standard maintenance time is about five minutes. If it takes longer, the print head will get dried, causing the damage.



Caution



If UV inks or waste fluids come in contact with skin or eyes, it may induce allergic reaction or inflammation. When you do this cleaning, always wear protective gloves (such as solvent-resistant gloves) and goggles to avoid contact with skin or eyes.

1

Wear protective equipment.

☞ ["Wearing protective equipment" P. 144](#)

2

Put the printer into CR maintenance state.

☞ ["1.Put the printer in CR maintenance state" P. 196](#)

3

Slowly open the covers in the following order:

- ① Front cover
- ② Maintenance cover L

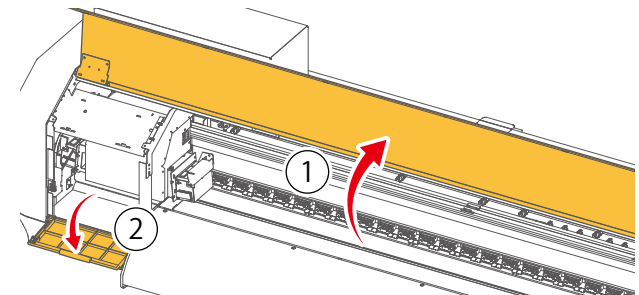

Before Use

Basic Operations

Various Settings

Maintenance

When problems occur

Appendix

About Maintenance

Wearing protective equipment

Agitating ink

Checking ink level and replacing cartridge

Emptying waste ink tank

Daily maintenance at the end of work

Printer maintenance

Replacing consumable parts

When not using the printer for a long period of time

Moving or transporting the printer

4

Using the cleaning stick dampened with small amount of ethanol, gently clean the ink and dust on the color sensor glass located at the bottom of the carriage.

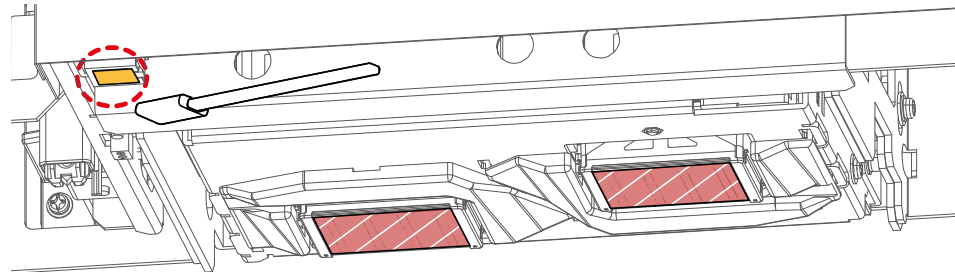

Clean this part (Do not push hard on the glass)

Never touch the print head surface.

5

- Close the maintenance cover L.
- Close the front cover.

6

- Check that [CR Maintenance End -> Enter] appears on the panel and then tap  [Enter] key.
- [CR Maintenance Start -> Enter] will appear.
 - Tap  [Home] key to end cleaning.

Important !!

If the problem persists, please contact your local MUTOH dealer.

Note

Put the used cleaning stick in a cleaning bag and dispose of it according to the local regulations.

Before Use

Basic Operations

Various Settings

Maintenance

When problems occur

Appendix

About Maintenance

Wearing protective equipment

Agitating ink

Checking ink level and replacing cartridge

Emptying waste ink tank

Daily maintenance at the end of work

Printer maintenance

Replacing consumable parts

When not using the printer for a long period of time

Moving or transporting the printer

Cleaning inside the printer

Preparation:

- Polyethylene gloves, rubber gloves, protective eye wear, mask
- Soft brush
- Paper towel or soft cloth
- Ethanol (more than 50% ethanol)



Caution



If UV inks or waste fluids come in contact with skin or eyes, it may induce allergic reaction or inflammation. When you do this cleaning, always wear protective gloves (such as solvent-resistant gloves) and goggles to avoid contact with skin or eyes.

1

Wear protective equipment.

 ["Wearing protective equipment" P. 144](#)

2

Open the front cover.

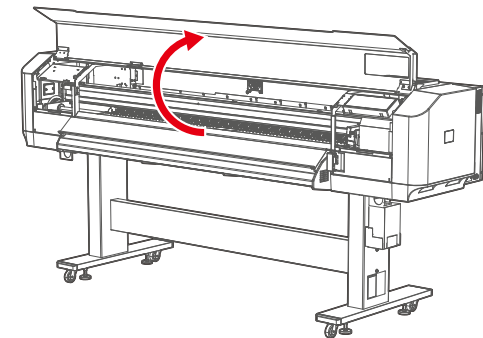

Before Use

Basic Operations

Various Settings

Maintenance

When problems occur

Appendix

About Maintenance

Wearing protective equipment

Agitating ink

Checking ink level and replacing cartridge

Emptying waste ink tank

Daily maintenance at the end of work

Printer maintenance

Replacing consumable parts

When not using the printer for a long period of time

Moving or transporting the printer

- 3 Use a soft brush to clean the dust off the pressure rollers.

Important !!

Do not use air duster to clean the dust inside the printer. This will cause dust to accumulate on the moving parts, leading to damage or noise.

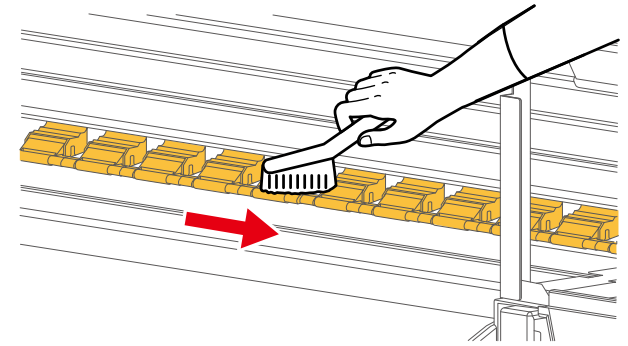

- 4 Using a paper towel or a soft cloth dampened with small amount of ethanol, clean the dust on the platen, media guide and edge holders.

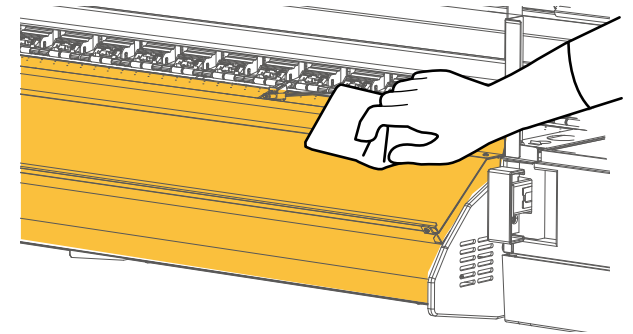

- 5 Close the front cover.

Before Use

Basic Operations

Various Settings

Maintenance

When problems occur

Appendix

About Maintenance

Wearing protective equipment

Agitating ink

Checking ink level and replacing cartridge

Emptying waste ink tank

Daily maintenance at the end of work

Printer maintenance

Replacing consumable parts

When not using the printer for a long period of time

Moving or transporting the printer

Replacing consumable parts

In order to maintain consistent printing quality, the following parts must be replaced periodically.





Parts	When to replace
Flushing box pad	When looking from the side, the ink deposits accumulated on the flushing pad is visible through the flushing box frame. (It depends on your use frequency. Check it periodically.) ☞ "Replacing the flushing box pad" P. 197
Cleaning wiper	Approximately every six months ☞ "Replacing the cleaning wiper" P. 201
Cutter	<ul style="list-style-type: none"> • When the cutter cannot cut media cleanly. • When the cut is fuzzy. ☞ "Replacing Cutter" P. 204
Filter of UV-LED lamp	Approximately every one month or when the filter gets dirty with ink or dust (It depends on your use frequency. Check it periodically.) ☞ "Replace the filter of UV-LED lamp" P. 207
Emitting window glass of UV-LED lamp	When the glass has cracks or a chip in the edge, or the dirt on the glass cannot be removed. (It depends on your use frequency. Check it periodically.) ☞ "Replace the emitting window glass of the UV-LED lamp" P. 209
Exhaust fan filter	When the area on the filter which is normally hidden behind the filter frame is also contaminated with ink (It depends on your use frequency. Check it periodically.) ☞ "Replacing and cleaning the exhaust fan filter" P. 212* * (Replacement or cleaning of exhaust fan filter can be done without putting the printer into CR maintenance mode.)

Before Use	About Maintenance
Basic Operations	Wearing protective equipment
Various Settings	Agitating ink
Maintenance	Checking ink level and replacing cartridge
When problems occur	Emptying waste ink tank
Appendix	Daily maintenance at the end of work
	Printer maintenance
	Replacing consumable parts
	When not using the printer for a long period of time
	Moving or transporting the printer

Replacement flow

1. Put the printer in CR maintenance state

1 Go to the "CR Maintenance" menu.

- Tap  [Home] key, [Menu1 Setup] appears.
- Tap  key several times to select [Menu 3 Maintenance].
- Tap  key, [Maintenance1 cleaning] appears.
- Tap  /  key to select [Maintenance2: CR Maintenance].

2 Tap key.

3 When [CR Maintenance Start -> Enter] appears, tap [Enter] key.

- The carriage moves to the left side of the printer.
- The message [CR Maintenance End -> Enter] appears.

4 The printer is now in the CR maintenance state. You can start replacement.

2. Replace consumable parts

Follow each instruction to replace a part.

 ["Replacing consumable parts" P. 195](#)

Before Use

Basic Operations

Various Settings

Maintenance

When problems occur

Appendix

About Maintenance

Wearing protective equipment

Agitating ink

Checking ink level and replacing cartridge

Emptying waste ink tank

Daily maintenance at the end of work

Printer maintenance

Replacing consumable parts

When not using the printer for a long period of time

Moving or transporting the printer

Replacing the flushing box pad

The flushing box is a part that collects inks spitted from the print head. Please replace the flushing box pad periodically. If used without replacing, it can cause damage to the print head.

When to replace:

- When looking from the side, the ink deposits accumulated on the flushing pad is visible through the flushing box frame. (Approximately every two months)
* It depends on your use frequency. Check it periodically.

What you need:

- Polyethylene gloves, rubber gloves, protective eye wear, mask
- Flushing box pad
- Waste paper (paper that ink does not bleed through)



Caution



Wear the protective gloves·glasses·mask and avoid contact with your eyes or skin. Eye or skin contact may cause slight irritation or bloodshot eyes. If in eyes or on skin, immediately flush with water. If irritation is present, seek medical advice/attention immediately.

Checking steps

1 Slowly open the covers in the following order:

- ① Front cover
- ② Maintenance cover R

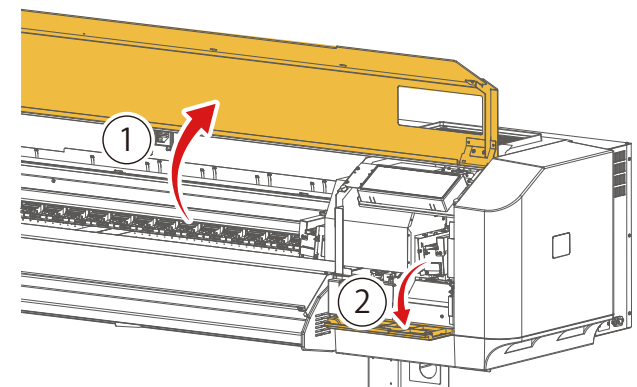

Before Use

Basic Operations

Various Settings

Maintenance

When problems occur

Appendix

About Maintenance

Wearing protective equipment

Agitating ink

Checking ink level and replacing cartridge

Emptying waste ink tank

Daily maintenance at the end of work

Printer maintenance

Replacing consumable parts

When not using the printer for a long period of time

Moving or transporting the printer

2 Check the pad of the flushing box.

- (When looking from the side) if the ink deposits accumulated on the flushing pad is visible through the flushing box frame, you need to replace it.

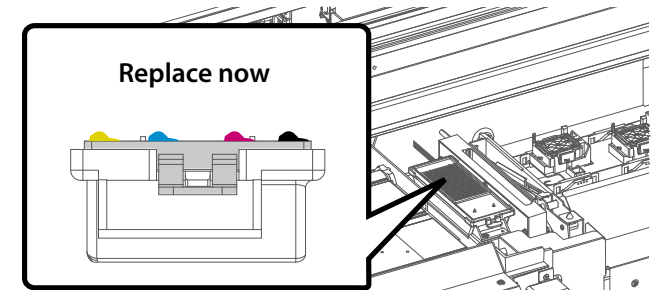

3 Close the maintenance cover R.

4 Close the front cover.

Replacing steps

1 Wear protective equipment.

 ["Wearing protective equipment" P. 144](#)

2 Put the printer into the CR maintenance mode.

 ["1.Put the printer in CR maintenance state" P. 196](#)

Before Use

Basic Operations

Various Settings

Maintenance

When problems occur

Appendix

About Maintenance

Wearing protective equipment

Agitating ink

Checking ink level and replacing cartridge

Emptying waste ink tank

Daily maintenance at the end of work

Printer maintenance

Replacing consumable parts

When not using the printer for a long period of time

Moving or transporting the printer

3 Slowly open the covers in the following order:

- ① Front cover
- ② Maintenance cover R

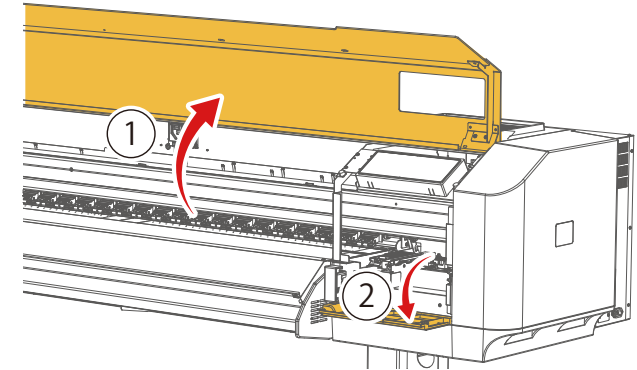

4 Cover the platen with the waste paper.

Important !!

Ink may drip when removing the pad from the flushing box. We recommend covering the floor with paper as well.

5 Remove the pad from the flushing box.

Important !!

Put the used pad in a plastic bag and dispose of it according to the local regulations.

Note

When removing the pad from the flushing box, be careful of ink dripping.

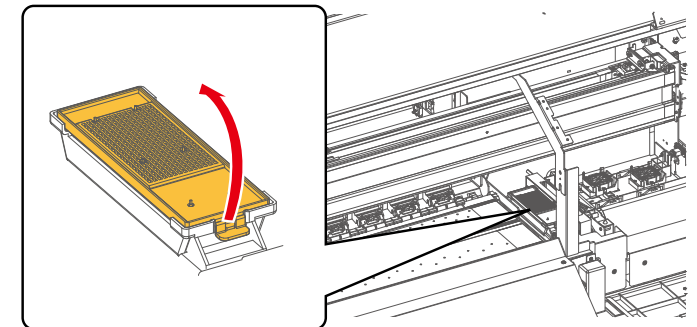

Before Use

Basic Operations

Various Settings

Maintenance

When problems occur

Appendix

About Maintenance

Wearing protective equipment

Agitating ink

Checking ink level and replacing cartridge

Emptying waste ink tank

Daily maintenance at the end of work

Printer maintenance

Replacing consumable parts

When not using the printer for a long period of time

Moving or transporting the printer

6 Attach a new pad to the flushing box.

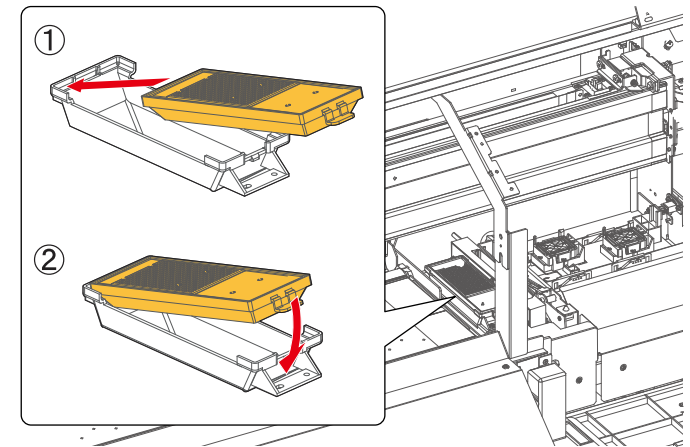

7 Close the maintenance cover R.

8 Close the front cover.

9 Check that [CR Maintenance End -> Enter] appears on the control panel and tap  [Enter] key.

- The message [CR Maintenance Start -> Enter] appears.
- Tap  [Home] key and the procedure ends here.

Before Use

Basic Operations

Various Settings

Maintenance

When problems occur

Appendix

About Maintenance

Wearing protective equipment

Agitating ink

Checking ink level and replacing cartridge

Emptying waste ink tank

Daily maintenance at the end of work

Printer maintenance

Replacing consumable parts

When not using the printer for a long period of time

Moving or transporting the printer

Replacing the cleaning wiper

The cleaning wiper is an essential part to make printing consistent. Please replace it periodically.

When to replace:

- Approximately every 6 months

What you need:

- Polyethylene gloves, rubber gloves, protective eye wear, mask
- Waste paper (paper that ink does not bleed through)
- Cleaning wiper



Caution



Wear the protective gloves·glasses·mask and avoid contact with your eyes or skin. Eye or skin contact may cause slight irritation or bloodshot eyes. If in eyes or on skin, immediately flush with water. If irritation is present, seek medical advice/attention immediately.

Replacement procedure

1

Wear protective equipment.

 ["Wearing protective equipment" P. 144](#)

2

Put the printer into the CR maintenance mode.

 ["1.Put the printer in CR maintenance state" P. 196](#)

Before Use

Basic Operations

Various Settings

Maintenance

When problems occur

Appendix

About Maintenance

Wearing protective equipment

Agitating ink

Checking ink level and replacing cartridge

Emptying waste ink tank

Daily maintenance at the end of work

Printer maintenance

Replacing consumable parts

When not using the printer for a long period of time

Moving or transporting the printer

3 Slowly open the covers in the following order:

- ① Front cover
- ② Maintenance cover R

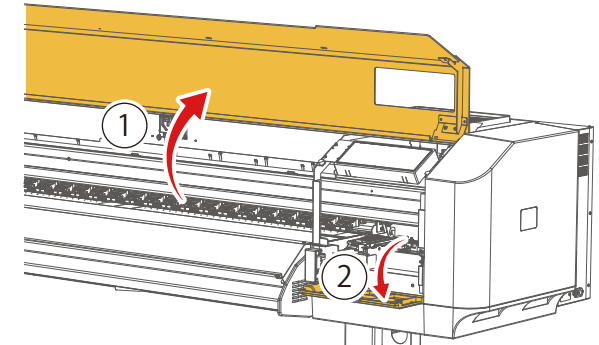

4 Cover the platen with the waste paper.

Important !!

Ink may drip from the cleaning wiper. We recommend covering the floor with paper as well.

5 Remove the cleaning wiper.

- a) Slide the hook on the wiper to the back to unhook from the wiper slot.
- b) Lift the hook and remove the cleaning wiper.

Important !!

Put the used pad in a plastic bag and dispose of it according to the local regulations.

Note

When removing the cleaning wiper, be careful of ink dripping.

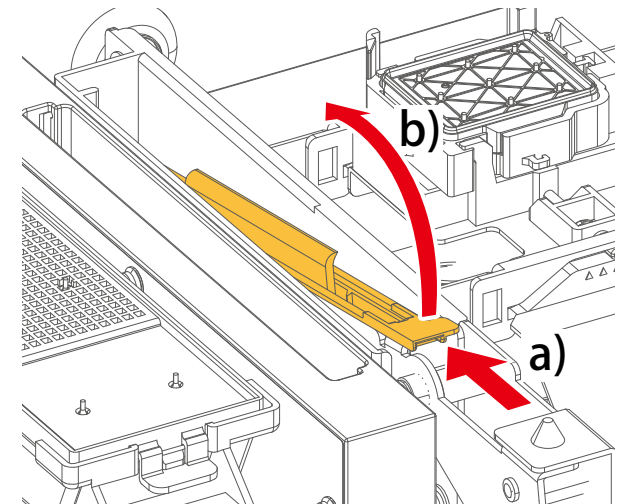

Before Use

Basic Operations

Various Settings

Maintenance

When problems occur

Appendix

About Maintenance

Wearing protective equipment

Agitating ink

Checking ink level and replacing cartridge

Emptying waste ink tank

Daily maintenance at the end of work

Printer maintenance

Replacing consumable parts

When not using the printer for a long period of time

Moving or transporting the printer

6

Follow these steps to attach a new cleaning wiper.

- a) Slide the back side of the new cleaning wiper into its slot.
- b) Press the wiper hook down until it clicks into place.

Important !!

Do not touch the rubber part of the cleaning wiper with bare hands. If sebum gets on the stick, it will damage the print head.

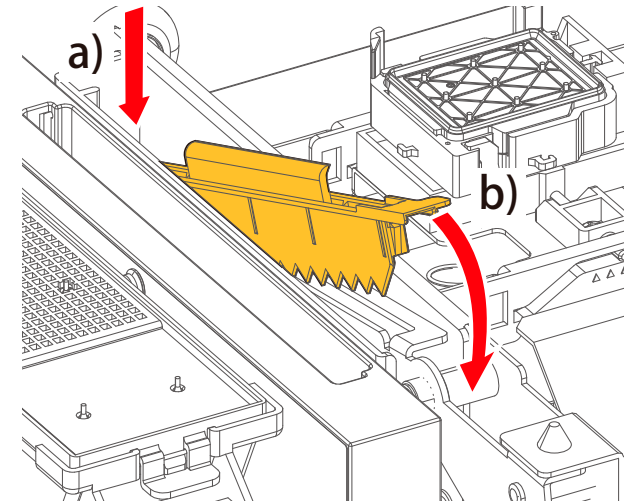

7

Close the maintenance cover R.

8

Close the front cover.

9

Check that [CR Maintenance End -> Enter] appears on the control panel and tap  [Enter] key.

- The message [CR Maintenance Start -> Enter] appears.
- Tap  [Home] key and the procedure ends here.

Before Use

Basic Operations

Various Settings

Maintenance

When problems occur

Appendix

About Maintenance

Wearing protective equipment

Agitating ink

Checking ink level and replacing cartridge

Emptying waste ink tank

Daily maintenance at the end of work

Printer maintenance

Replacing consumable parts

When not using the printer for a long period of time

Moving or transporting the printer

Replacing Cutter

When to replace:

- When the cutter cannot cut a roll media cleanly.
- When the cut is fuzzy.

What you need:

- Replacement cutter blade



Caution



- **Do not push the tab on the cutter holder too hard or release suddenly.**

There is a spring under the cutter so that the cutter may jump out from the holder.

- **Do not touch the cutter blade.**

It may cause injury.

Replacement procedure

- 1 Put the printer into the CR maintenance mode.
 "1.Put the printer in CR maintenance state" P. 196

- 2 Slowly open the covers in the following order:
 - ① Front cover
 - ② Maintenance cover L

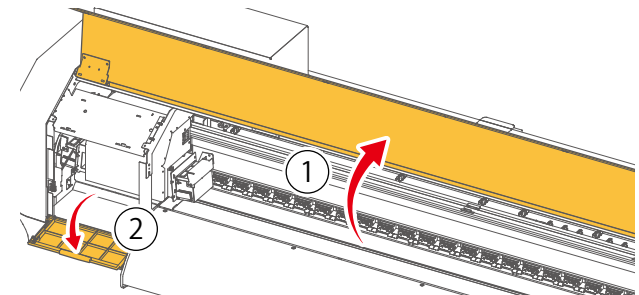

Before Use

Basic Operations

Various Settings

Maintenance

When problems occur

Appendix

About Maintenance

Wearing protective equipment

Agitating ink

Checking ink level and replacing cartridge

Emptying waste ink tank

Daily maintenance at the end of work

Printer maintenance

Replacing consumable parts

When not using the printer for a long period of time

Moving or transporting the printer

- 3 Lightly push the tab on the cutter holder and turn the cutter cap in the direction shown in the illustration.

Important !!

Do not push down the cutter cap. It may damage the part.

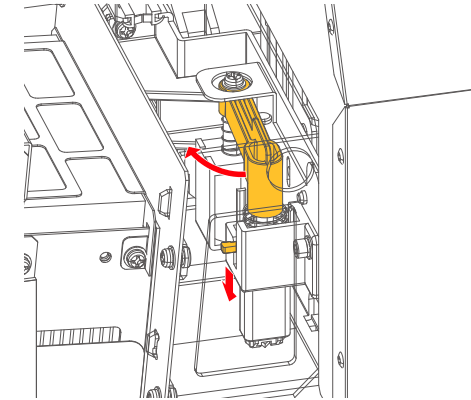

- 4 Remove the cutter.

Note

Put the used cutter in a plastic bag and dispose of it according to the local regulations.

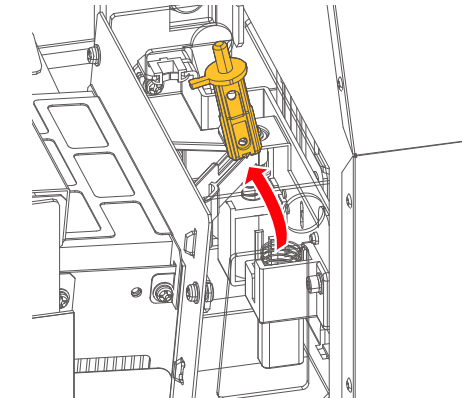

- 5 Attach a new cutter.

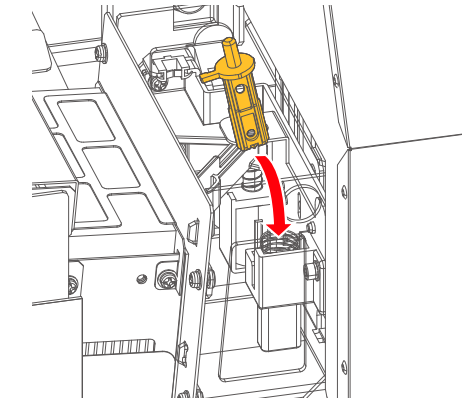

Before Use

Basic Operations

Various Settings

Maintenance

When problems occur

Appendix

About Maintenance

Wearing protective equipment

Agitating ink

Checking ink level and replacing cartridge

Emptying waste ink tank

Daily maintenance at the end of work

Printer maintenance

Replacing consumable parts

When not using the printer for a long period of time

Moving or transporting the printer

6 Lightly push the tab on the cutter holder and put the cutter cap back to the original position.

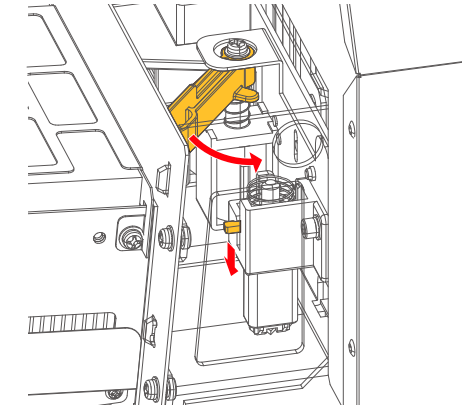

7 Close the maintenance cover L.

8 Close the front cover.

9 Check that [CR Maintenance End -> Enter] appears on the control panel and tap  [Enter] key.

- The message [CR Maintenance Start -> Enter] appears.
- Tap  [Home] key and the procedure ends here.

Before Use

Basic Operations

Various Settings

Maintenance

When problems occur

Appendix

About Maintenance

Wearing protective equipment

Agitating ink

Checking ink level and replacing cartridge

Emptying waste ink tank

Daily maintenance at the end of work

Printer maintenance

Replacing consumable parts

When not using the printer for a long period of time

Moving or transporting the printer

Replace the filter of UV-LED lamp

The UV-LED lamp filter protects the lamp from ink mist. Using a dirty filter will cause damage to the lamp.

Make sure you replace it regularly.

When to replace:

- Approximately once a month or when the filter gets dirty by dust or ink.(It depends on usage. Please check regularly.)

What you need

- Polyethylene gloves, rubber gloves, protective eye wear, mask
- New filter



Caution



- Wear the protective gloves glasses mask and avoid contact with your eyes or skin. Eye or skin contact may cause slight irritation or bloodshot eyes. If in eyes or on skin, immediately flush with water. If irritation is present, seek medical advice/attention immediately.



- The UV-LED lamp may get hot after printing. Allow the lamp to cool down for 10 minutes after printing and then start maintenance.

Replacement procedure

1

Wear protective equipment.

 ["Wearing protective equipment" P. 144](#)

2

Put the printer into the CR maintenance mode.

 ["1.Put the printer in CR maintenance state" P. 196](#)

Before Use

Basic Operations

Various Settings

Maintenance

When problems occur

Appendix

About Maintenance

Wearing protective equipment

Agitating ink

Checking ink level and replacing cartridge

Emptying waste ink tank

Daily maintenance at the end of work

Printer maintenance

Replacing consumable parts

When not using the printer for a long period of time

Moving or transporting the printer

3 Slowly open the covers in the following order:

- ① Front cover
- ② Maintenance cover L

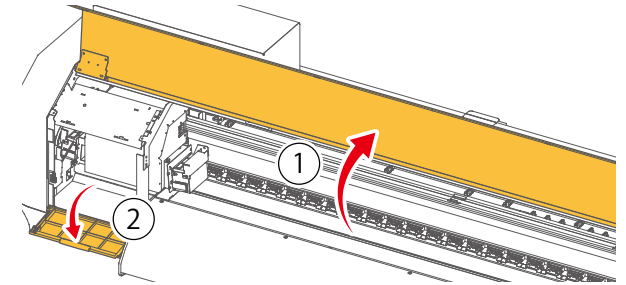

4 While supporting the UV-LED lamp with one hand, remove the filter from the lamp.

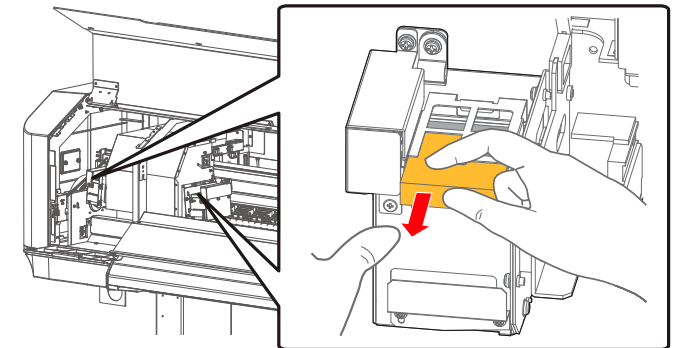

5 Replace with a new filter.

- Firmly insert it into the filter slot.

6 Close the maintenance cover L.

7 Close the front cover.

8 Check that [CR Maintenance End -> Enter] appears on the control panel and tap  [Enter] key.

- The message [CR Maintenance Start -> Enter] appears.
- Tap  [Home] key and the procedure ends here.

Before Use

Basic Operations

Various Settings

Maintenance

When problems occur

Appendix

About Maintenance

Wearing protective equipment

Agitating ink

Checking ink level and replacing cartridge

Emptying waste ink tank

Daily maintenance at the end of work

Printer maintenance

Replacing consumable parts

When not using the printer for a long period of time

Moving or transporting the printer

Replace the emitting window glass of the UV-LED lamp

An emitting window glass is a part that protects the UV-LED lamp. Using the printer with dirty or broken glass will cause damage to the lamp or insufficient ink curing. Please replace the glass as needed.

When to replace:

- When the glass has cracks or chips, or ink sticking to the glass cannot be removed.

What you need

- Polyethylene gloves, rubber gloves, protective eye wear, mask
- New glass



Caution



- Wear the protective gloves glasses mask and avoid contact with your eyes or skin. Eye or skin contact may cause slight irritation or bloodshot eyes. If in eyes or on skin, immediately flush with water. If irritation is present, seek medical advice/attention immediately.



- The UV-LED lamp may get hot after printing. Allow the lamp to cool down for 10 minutes after printing and then start maintenance.

Replacement procedure

1

Wear protective equipment.



["Wearing protective equipment" P. 144](#)

2

Put the printer into the CR maintenance mode.



["1.Put the printer in CR maintenance state" P. 196](#)

Before Use

Basic Operations

Various Settings

Maintenance

When problems occur

Appendix

About Maintenance

Wearing protective equipment

Agitating ink

Checking ink level and replacing cartridge

Emptying waste ink tank

Daily maintenance at the end of work

Printer maintenance

Replacing consumable parts

When not using the printer for a long period of time

Moving or transporting the printer

3 Slowly open the covers in the following order:

- ① Front cover
- ② Maintenance cover L

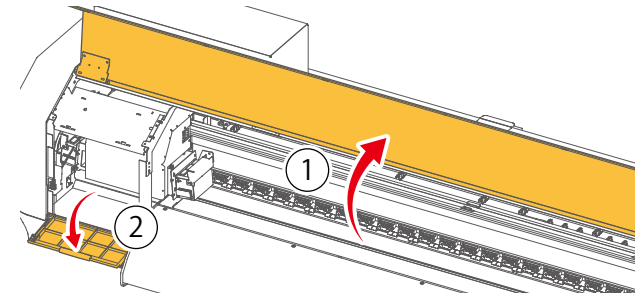

4 Check the glass and replace it if there are any cracks or chips.

1. Slide up the left side of the exhaust fan cover. The right side screw serves as a fulcrum.
2. Slide the glass attached on the bottom of the lamp towards the front to remove it.
3. Check for cracks, chips, or ink on the glass
4. Attach a new glass to the UV-LED lamp. Firmly slide it into the end and then put the exhaust fan cover back in place.

Important!

Make sure that the emitting window glass is attached to the lamp and the exhaust fan cover is put back in place. Using your printer without them will cause damage to the lamp.

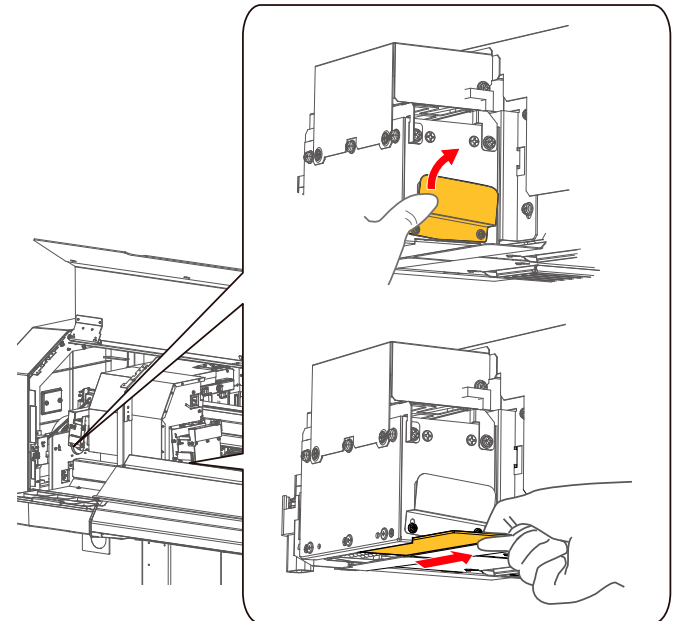

Before Use	About Maintenance
Basic Operations	Wearing protective equipment
Various Settings	Agitating ink
Maintenance	Checking ink level and replacing cartridge
When problems occur	Emptying waste ink tank
Appendix	Daily maintenance at the end of work
	Printer maintenance
	Replacing consumable parts
	When not using the printer for a long period of time
	Moving or transporting the printer

5 Close the maintenance cover L.

6 Close the front cover.

7 Check that [CR Maintenance End -> Enter] appears on the control panel and tap  [Enter] key.

- The message [CR Maintenance Start -> Enter] appears.
- Tap  [Home] key and the procedure ends here.

Before Use

Basic Operations

Various Settings

Maintenance

When problems occur

Appendix

About Maintenance

Wearing protective equipment

Agitating ink

Checking ink level and replacing cartridge

Emptying waste ink tank

Daily maintenance at the end of work

Printer maintenance

Replacing consumable parts

When not using the printer for a long period of time

Moving or transporting the printer

Replacing and cleaning the exhaust fan filter

Exhaust fan filters collect ink mist generated inside the printer. You must replace it regularly according to the replacement cycle. Using your printer without replacing this filter will affect printer performance or print quality.

When to replace or clean:

- When the area on the filter which is normally hidden behind the filter frame is also contaminated with ink (Since it differs depending on usage frequency, please check periodically.)

What you need:

- Polyethylene gloves, rubber gloves, protective eye wear, mask
- Replacement exhaust fan filter
- Paper towel or Soft cloth
- Ethanol (commercially available item: Use one with a concentration of 50% or higher.)



Caution



Wear the protective gloves·glasses·mask and avoid contact with your eyes or skin. Eye or skin contact may cause slight irritation or bloodshot eyes. If in eyes or on skin, immediately flush with water. If irritation is present, seek medical advice/attention immediately.

Replacement procedure

1 Wear protective equipment.
 [“Wearing protective equipment” P. 144](#)

2 Check that the printer is not in operation.

Before Use

Basic Operations

Various Settings

Maintenance

When problems occur

Appendix

About Maintenance

Wearing protective equipment

Agitating ink

Checking ink level and replacing cartridge

Emptying waste ink tank

Daily maintenance at the end of work

Printer maintenance

Replacing consumable parts

When not using the printer for a long period of time

Moving or transporting the printer

3 Remove the exhaust fan filter from the exhaust fan.

Important!

When removing the exhaust fan filter, be cautious of ink drops.

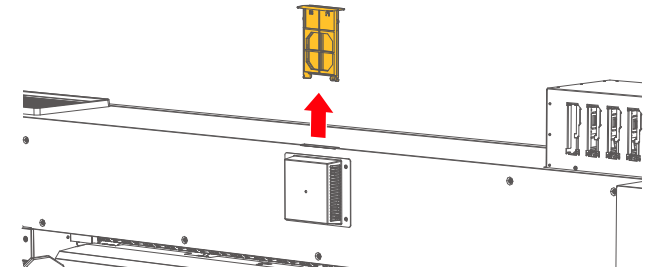

4 Open the cover on the filter.

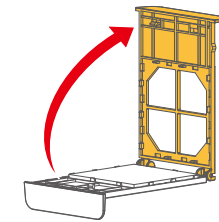

5 Check the filter to see if it needs to be changed.

- If the area on the filter which is normally hidden behind the frame of the fan filter is contaminated with ink, replace it with new one.

After replacement

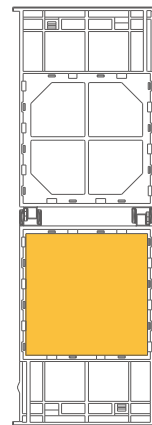

Still good to use

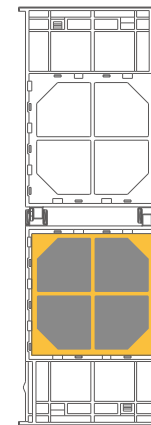

Must replace now

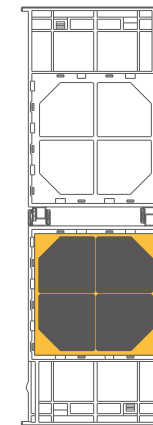

If the filter looks dirty as shown on the left, you must replace with new one.

Before Use

Basic Operations

Various Settings

Maintenance

When problems occur

Appendix

About Maintenance

Wearing protective equipment

Agitating ink

Checking ink level and replacing cartridge

Emptying waste ink tank

Daily maintenance at the end of work

Printer maintenance

Replacing consumable parts

When not using the printer for a long period of time

Moving or transporting the printer

6

If needed, replace with a new filter.

- Remove the filter from the exhaust fan filter cover.

Important!

- When removing the filter, be cautious of ink drops.
- Put the used filter in a plastic bag and dispose of it according to the local regulations.

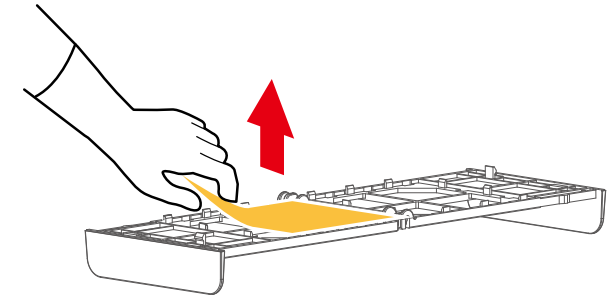

7

Using a soft cloth or a paper towel dampened with little ethanol, clean the cover to remove dirt.

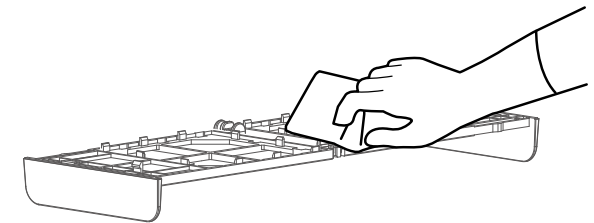

8

Attach a new filter to the cover.

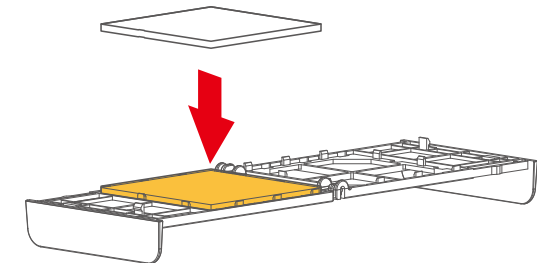

9

Close the cover of the exhaust fan filter.

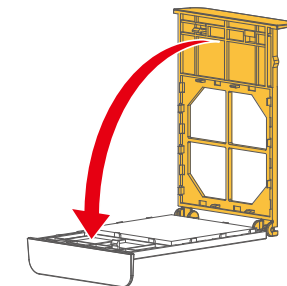

Before Use

Basic Operations

Various Settings

Maintenance

When problems occur

Appendix

About Maintenance

Wearing protective equipment

Agitating ink

Checking ink level and replacing cartridge

Emptying waste ink tank

Daily maintenance at the end of work

Printer maintenance

Replacing consumable parts

When not using the printer for a long period of time

Moving or transporting the printer

10 After replacing a filter, open the front cover, then clean the inside of the exhaust fan.

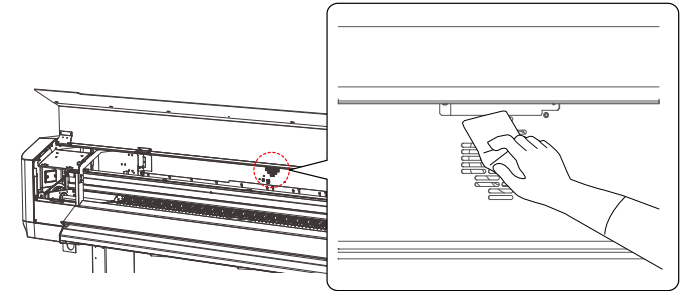

11 Close the front cover, then attach the filter to the exhaust fan.

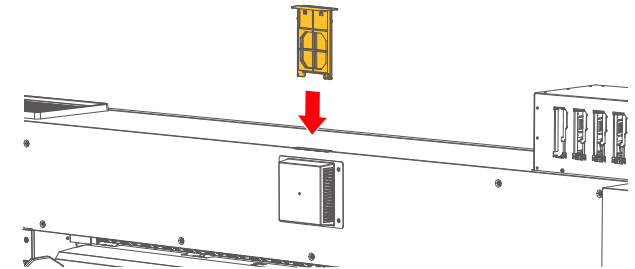

Before Use

Basic Operations

Various Settings

Maintenance

When problems occur

Appendix

About Maintenance

Wearing protective equipment

Agitating ink

Checking ink level and replacing cartridge

Emptying waste ink tank

Daily maintenance at the end of work

Printer maintenance

Replacing consumable parts

When not using the printer for a long period of time

Moving or transporting the printer

When not using the printer for a long period of time

If you are not using the printer for a long period of time (maximum one month), follow these steps to power off the printer.

1. Perform a daily maintenance

1 Prepare the items required for daily maintenance.

 ["Step 1. Preparations for maintenance" P. 172](#)

2 Put the printer in daily maintenance state.

 ["1.Put the printer in daily maintenance state." P. 189](#)

3 Clean the following printer parts:

- Parts that need to be cleaned by a daily maintenance

 ["Step 3. Perform a daily maintenance" P. 174](#)

- Color sensor, Inside the printer





 ["Cleaning the color sensor" P. 191,"Cleaning inside the printer" P. 193](#)

4 Once the maintenance is complete, close the front cover and maintenance cover and tap  [Enter] key.

 ["Step 4. Ending the daily maintenance" P. 183](#)

2. Flush ink out of printer

1 Go to the "Ink Discharge" menu.

- Tap  [Home] key. [Menu1 Setup] appears.
- Tap  key several times to select [Menu 3 Maintenance].
- Tap  key. [Maintenance1 Cleaning] appears.
- Tap  /  key to select [Maintenance3 Ink Discharge].

Before Use

Basic Operations

Various Settings

Maintenance

When problems occur

Appendix

About Maintenance

Wearing protective equipment

Agitating ink

Checking ink level and replacing cartridge

Emptying waste ink tank

Daily maintenance at the end of work

Printer maintenance

Replacing consumable parts



When not using the printer for a long period of time

Moving or transporting the printer

2 Tap  key

- When [Ink Discharge Start -> Enter] appears, tap  [Enter] key.

3 If the message [Empty Waste Ink Tank then Tap Enter] appears, drain waste fluids into a container.

- Tap  [Enter] key.
-  [“Emptying waste ink tank” P. 167](#)

4 When [Remove Cartridges] appears, remove all the ink cartridges (or ink bags) from the ink slots.

- When [Discharging **%] appears, it begins flushing ink out of the printer.
- When [No Cart xxxxx] appears, drain waste fluids into a container to empty the waste ink tank.
-  [“Emptying waste ink tank” P. 167](#)
- For ink cartridges, put them in the original packaging boxes and store in a light-shielded area.
- For ink bags, after removing from the high-capacity ink pack adapters, put them in the original packaging boxes and store them with high-capacity ink pack adapters in a light-shielded area.

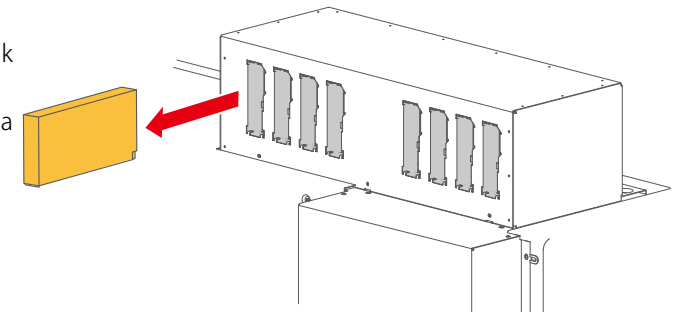

5 The procedure ends here.

3. Power off the printer

1 Press and hold the Power button for more than two seconds.

- The printer begins powering off.

Before Use

Basic Operations

Various Settings

Maintenance

When problems occur

Appendix

About Maintenance

Wearing protective equipment

Agitating ink

Checking ink level and replacing cartridge

Emptying waste ink tank

Daily maintenance at the end of work

Printer maintenance

Replacing consumable parts

When not using the printer for a long period of time

Moving or transporting the printer

Moving or transporting the printer

Moving the printer

This section describes how to move the printer.

Important !!

- When moving the printer, make sure to keep it level.
- Do not tilt the product. The ink inside the printer may spill. MUTOH cannot guarantee that the printer can run properly.
- Before moving the printer, empty the waste ink tank. Failure to do so may result in damage to the product.

Preparation before moving

- 1 Make sure that the printer is turned OFF.
☞ ["Turning the power OFF" P. 47](#)
- 2 Empty the waste ink tank.
☞ ["Emptying waste ink tank" P. 167](#)
- 3 Remove all the cables including the power cord.
- 4 Slowly open the covers in the following order:
 - ① Front cover
 - ② Maintenance cover R

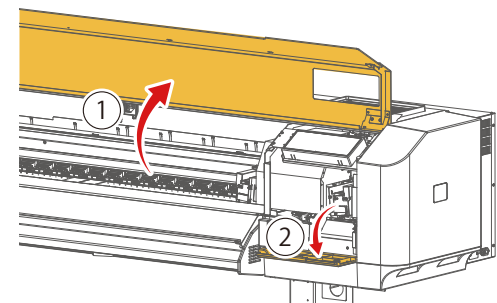

Before Use

Basic Operations

Various Settings

Maintenance

When problems occur

Appendix

About Maintenance

Wearing protective equipment

Agitating ink

Checking ink level and replacing cartridge

Emptying waste ink tank

Daily maintenance at the end of work

Printer maintenance

Replacing consumable parts

When not using the printer for a long period of time

Moving or transporting the printer

- 5 Install the protective material on the underside of the carriage.

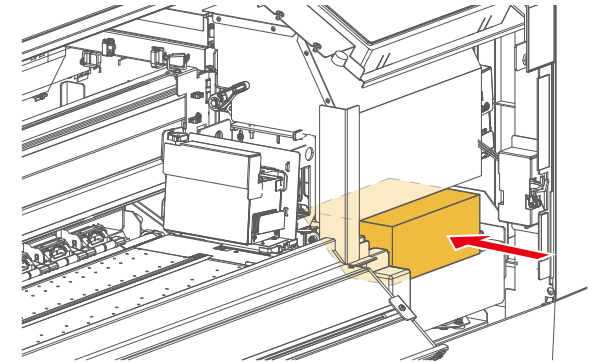

- 6 Close the maintenance cover R.

- 7 Close the front cover.

- 8 Loosen the four adjusters of the stand by turning them anticlockwise.

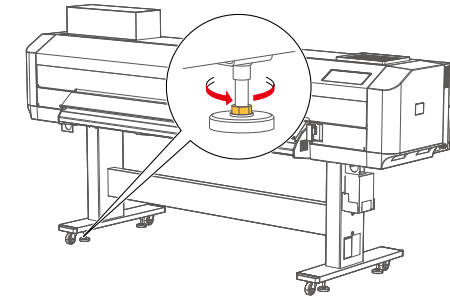

- 9 Move the printer.

Before Use

Basic Operations

Various Settings

Maintenance

When problems occur

Appendix

About Maintenance

Wearing protective equipment

Agitating ink

Checking ink level and replacing cartridge

Emptying waste ink tank

Daily maintenance at the end of work

Printer maintenance

Replacing consumable parts

When not using the printer for a long period of time

Moving or transporting the printer

Installation after moving

1 Select a suitable place for installation.
☞ Startup Guide "Check before installation"

2 Move and install the printer to the location.

3 Slowly open the covers in the following order:

- ① Front cover
- ② Maintenance cover R

4 Remove the protective material under the carriage.

Note

Keep the removed protective material for reuse. You will need them when moving or transporting the printer.

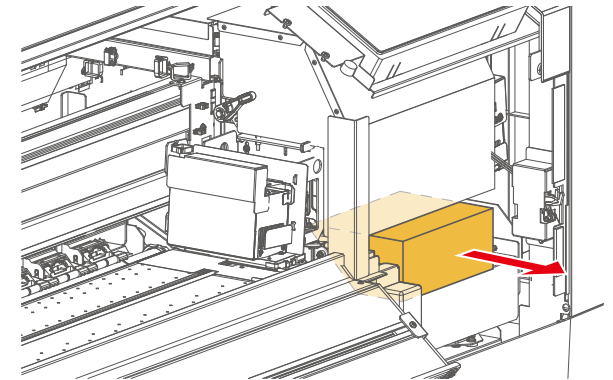

5 Close the maintenance cover R.

6 Close the front cover.

7 Connect the cables including the power cord.

Before Use	About Maintenance
Basic Operations	Wearing protective equipment
Various Settings	Agitating ink
Maintenance	Checking ink level and replacing cartridge
When problems occur	Emptying waste ink tank
Appendix	Daily maintenance at the end of work
	Printer maintenance
	Replacing consumable parts
	When not using the printer for a long period of time
	Moving or transporting the printer

8 Run a nozzle check to make sure all nozzles are clear.
 ["Run a nozzle check" P. 61](#)

9 Perform a print quality calibration.
 ["Print quality calibration \("Adjust Print"\)" P. 72](#)

Transporting the printer

This product must be repacked in the original packaging and packaging materials as you purchased to protect the printer from vibration and shocks.

Important !!

When transporting the printer, make sure to consult your local MUTOH dealer.

Before Use

Basic Operations

Various Settings

Maintenance

When problems occur

Appendix

About Maintenance

Wearing protective equipment

Agitating ink

Checking ink level and replacing cartridge

Emptying waste ink tank

Daily maintenance at the end of work

Printer maintenance

Replacing consumable parts

When not using the printer for a long period of time

Moving or transporting the printer

Initial ink charging after flushing ink out of the printer

- 1 Press and hold the Power button for more than two seconds.
 - The small LED above the button and all the keys light up.
 - Printer initialization begins.

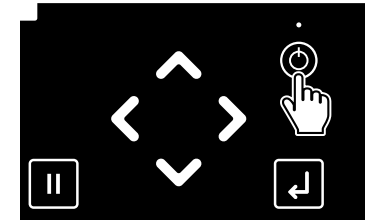

- 2 When [Ink Charge Start -> Enter] appears, check that the waste ink tank is empty or only a small amount of fluids is collected. Then tap  [Enter] key.

- 3 When the message [Empty Waste Ink Tank then Tap Enter] appears, drain waste fluid into a container.
 - ☞ ["Emptying waste ink tank" P. 167](#)
 - After emptying the tank, tap  [Enter] key.

- 4 When [Insert Ink Cartridges] appears, agitate the ink and then insert it into each ink slot.

Important!

Be sure to use new ink cartridges (ink bags). If a used ink cartridge (ink bag) does not have enough ink, it will run out of ink during initial ink charging and will consume more ink.

- 5 Perform initial ink charging.
 - ☞ ["When using ink cartridges" P. 223](#)
 - ☞ ["When using ink bags with high-capacity ink pack adapters" P. 224](#)

Before Use

Basic Operations

Various Settings

Maintenance

When problems occur

Appendix

About Maintenance

Wearing protective equipment

Agitating ink

Checking ink level and replacing cartridge

Emptying waste ink tank

Daily maintenance at the end of work

Printer maintenance

Replacing consumable parts

When not using the printer for a long period of time

Moving or transporting the printer

When using ink cartridges

1 Follow these steps to agitate ink in a new ink cartridge.

- Hold the ink cartridge with the ink outlet facing up and wait for three seconds.
- Invert it with the ink outlet facing down and wait for three seconds.
- Repeat this ten times (white ink : twenty times)

Important !!

Make sure to use new ink cartridges.

Note

There is no need to agitate varnish ink.

3 sec.



3 sec.

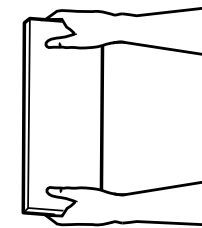

x 10

2 Insert the ink cartridge into the into the ink slot.

- Make sure to match the color of the ink cartridge with the color of the label attached to each ink slot. (This illustration is an example of 4-color configuration)
- Hold the cartridge with the arrow mark facing up.
- Insert it all the way in.

Important !!

Make sure to use the printer with the same ink configuration as before transporting and insert each ink cartridge into the original ink slot.

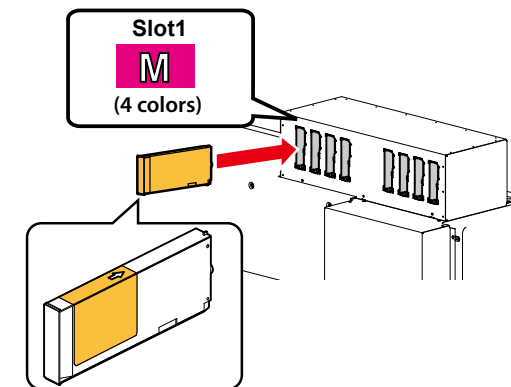

Before Use

Basic Operations

Various Settings

Maintenance

When problems occur

Appendix

About Maintenance

Wearing protective equipment

Agitating ink

Checking ink level and replacing cartridge

Emptying waste ink tank

Daily maintenance at the end of work

Printer maintenance

Replacing consumable parts

When not using the printer for a long period of time

Moving or transporting the printer

When using ink bags with high-capacity ink pack adapters

- 1 Follow these steps to agitate ink in a new ink bag.
 - Hold the ink bag with the ink outlet facing up and wait for three seconds.
 - Invert it with the ink outlet facing down and wait for three seconds.
 - Repeat this ten times (white ink : twenty times)

Important !!

Make sure to use a new ink bag.

Note

There is no need to agitate varnish ink.

3 sec.

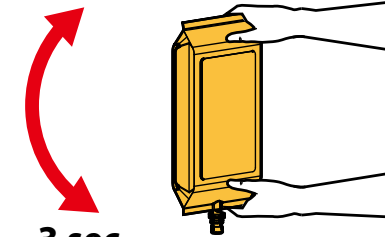

3 sec.

x 10

- 2 Insert the smartchip card into the card slot on the high-capacity ink pack adapter.

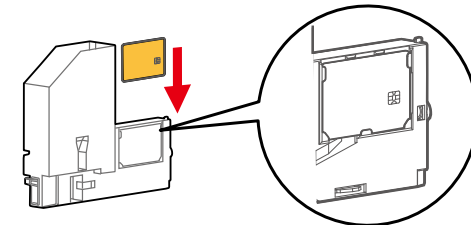

- 3 Insert the ink bag into the high-capacity ink pack adapter while lowering the lock lever on the adapter.

- Insert the ink bag all the way in to seat properly.

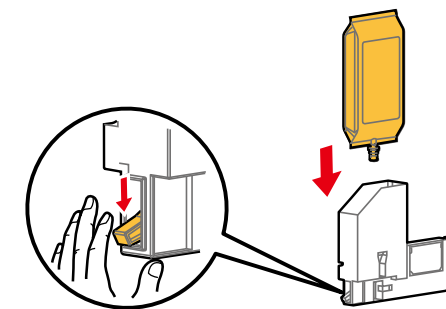

Before Use

Basic Operations

Various Settings

Maintenance

When problems occur

Appendix

About Maintenance

Wearing protective equipment

Agitating ink

Checking ink level and replacing cartridge

Emptying waste ink tank

Daily maintenance at the end of work

Printer maintenance

Replacing consumable parts

When not using the printer for a long period of time

Moving or transporting the printer

4 Ensure that the ink bag is fully seated and locked.

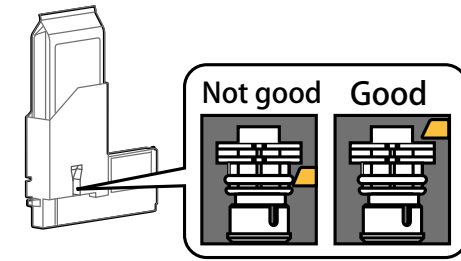

5 Check that the lock lever of the high-capacity ink pack adapter is back to its original position.

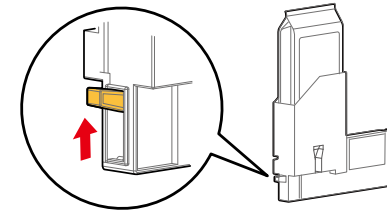

6 Cover the ink bag with the light-blocking cover.

Note

Attach it so that the light-blocking cover comes inside the high-capacity ink pack adapter.

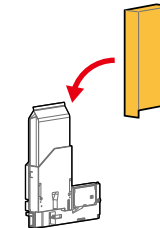

7 Insert the high-capacity ink pack adapter into the ink slot.

- Make sure to match the color of the ink bag with the color of the label attached to each ink slot. (This illustration is an example of 4-color configuration)
- Insert it all the way in.

Important !!

Make sure you insert it in the original ink slot. Do not insert in a different ink slot even if it is the same color.

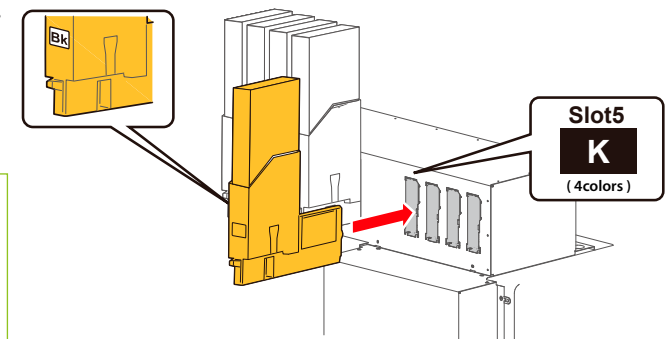

Before Use	About Maintenance
Basic Operations	Wearing protective equipment
Various Settings	Agitating ink
Maintenance	Checking ink level and replacing cartridge
When problems occur	Emptying waste ink tank
Appendix	Daily maintenance at the end of work
	Printer maintenance
	Replacing consumable parts
	When not using the printer for a long period of time
	Moving or transporting the printer

The procedure after installing ink

- 1 [Ink Refill * *%] appears.
 - Ink charging begins.



Caution



Do not attempt the following actions during ink charging:

- Power off the printer.
- Disconnect the power cord.
- Open the front cover.
- Open the maintenance cover.
- Release the pressure rollers.

- 2 Once the ink has been filled, the message [Media end] will appear on the panel.
 - The ink charging is complete.

Important !!

If you run a nozzle check print immediately after initial ink charging is complete, the following symptom may appear.

- Lines are blurred
- Image is partially not printed

In such cases, follow **“Cleaning” P. 126** to perform [Little Charge] cleaning. Then print and check the result.

If there is no improvement, leave the printer for at least one hour and then perform cleaning or [Little Charge]. Once finished, print an image again.

If the problem still persists, please contact your local MUTOH dealer.

When problems occur

Messages and Error Messages 228

Troubleshooting 239

Before Use

Basic Operations

Various Settings

Maintenance

When problems occur

Appendix

Messages and Error Messages

Troubleshooting

Messages and Error Messages

This section describes messages displayed during normal printer operation or when errors occur, and solutions to the messages.

Status messages

This section describes messages displayed during printer normal operation.

When the product is operating correctly, each operation status is displayed on the printer control panel as below.

Display	Description
Activation required	Printer has not been activated yet. Follow the Startup Guide to activate your printer. For details, see XPJ-1682UR Startup Guide.
F / W update required >> Controller F / W <<	MUTOH Status Monitor (MSM) is required to update the controller firmware. For the method of updating, see the section "Firmware Update" in the MUTOH Status Monitor operation manual.
Ready to Print PG: Low W: XXXX mm	Ready-to-print state (Media is loaded).
Media End PG: Low	Ready-to-print state (Media is not loaded).  "Loading a roll media into the printer" P. 49
Receiving PG: Low W: XXXX mm	Job is being received.
Converting PG: Low W: XXXX mm	Job is being converted.
Printing PG: Low W: XXXX mm	Job is being printed.
Remain: XXX.Xm	Displays the length of the data that has not been printed in meters for the data currently being printed.
Remain Time: XXX.Xmin	Displays the time remaining to print in minutes for the data currently being printed.
Media Remain: XXX m	Displays the remaining length of the media currently set in meters.

Before Use

Basic Operations

Various Settings





Maintenance

When problems occur

Appendix

Messages and Error Messages

Troubleshooting

Display	Description
Pausing Print Cancel Print -> Enter	Printing is being paused. • Tap  (Cancel) key to resume printing. • Tap  (Enter) key to cancel the print job.
Canceling PG: Low W: ***mm	Printing is being canceled.
Feeding Forward	Feeding media forward.
Feeding Backward	Feeding media backward.
Cleaning **%	Cleaning is being performed. Please wait a while.
Ink Refill **%	Ink is being filled. Please wait a while.
Discharging **%	Ink is being discharged. Please wait a while.
Perform Daily Maint.	The scheduled time has passed since the last daily maintenance. Perform a daily maintenance.  "Cleaning each part of the printer" P. 189
Washing Head	Charging and discharging the cleaner for the initial cleaning, or cleaning the print head for the head cleaning. Please wait a while.
User: Type ** OK?	Initializing the media. Please wait a while.
Media Initial	(** represents the selected user type.)
Move To Origin Position	The print head is moving to the print start position to check the print origin. Please wait a while.
Confirm Position End -> Enter	The print head has moved to the print start position. If it shows the intended position, tap  (Enter).
Power Off	Turning OFF the printer. Wait for a while.
Insert Ink Cartridges	Charging the ink. Insert ink cartridges.

Before Use

Basic Operations

Various Settings



Maintenance

When problems occur

Appendix

Messages and Error Messages

Troubleshooting

Display	Description
Insert Cleaning Cart.	Washing Print head. Install cleaning bags.
Remove Cartridges	Washing Print head or discharging ink. Remove ink cartridges.
Empty Waste Ink Tank then Tap Enter	The waste ink tank became full during initial filling. Empty the waste ink tank and then tap the  (Enter) key.
S/C Reading	Reading the smart chip card.
*** Remote Mode *** End -> Enter	The remote panel mode is running, via MSM or similar. In the remote panel mode, operations via the printer control panel are not possible. To terminate the remote panel mode, press the  (Enter) key for more than two seconds.
Roll Remain Error	The remaining roll paper count has become 0. (Printing stops)
Roll Near End: *m	The remaining roll paper count is almost 0. The remaining roll paper is *m.
Life Times [Pump*] OK -> Enter	The operational life of the pump motor has almost expired. (Continues operation) Contact your local MUTOH dealer.
Life Times [CR Motor] OK -> Enter	The operation life CR motor has almost expired. (Continues operation) Contact your local MUTOH dealer.
Life Times [PF Motor] OK -> Enter	The operational life of the PF motor has almost expired. (Continues operation) Contact your local MUTOH dealer.
Life Times [UV Lamp*] OK -> Enter	The operational life of the UV lamp has almost expired. (Continues operation) Contact your local MUTOH dealer.

Before Use	
Basic Operations	
Various Settings	
Maintenance	
When problems occur	Messages and Error Messages
Appendix	Troubleshooting

Display	Description
Life Times [C Pump*] OK -> Enter	The operational life of the circulation pump has almost expired. (Continues operation) Contact your local MUTOH dealer.
Ink Circulation **%	Ink circulation is being performed in the printer.

Before Use

Basic Operations

Various Settings

Maintenance

When problems occur

Appendix

Messages and Error Messages





Troubleshooting

Error message display and remedies

This section describes error messages and remedies.

Error messages are displayed when certain failures occur during printer operation.

If an error that can be displayed occurs, the printer may display the following error messages on the printer control panel and stop operation.

Display	Description
Cover Open	Any or all of covers (front cover, maintenance cover R, maintenance cover L) are open. Close the cover.
Use Lever to Lower Pressure Rollers	The pressure rollers are released. Lower the pressure rollers.
Load Media	The media is not loaded. Load the media.  "Loading a roll media into the printer" P. 49
Undefined Media	Media detection has failed. (Stops operation) Reload the media.
Media Slant	Media skews. (Stops operation) Reload the media.
Media Cut Error	The media was not cut. (Stops operation) Reload the media.
End Of Roll	The printer is out of roll media. (Stops operation) Load a new media.  "Loading a roll media into the printer" P. 49
Change Head Gap *** PG: *** W : XXXX mm	The head height on the printer does not match with the one specified on the print data. Change the setting to the head height displayed.  "Printhead Height" P. 91
[****] Ink End	Ink is out. (Stops operation) Replace with a new ink cartridge (ink bag).  "Replacing with a new ink" P. 160

Before Use

Basic Operations

Various Settings





Maintenance

When problems occur

Appendix

Messages and Error Messages

Troubleshooting

	Display	Description
Ink End		Ink is out (in the example on the left, slot 6 and slot 7) (The printer will stop operation). Remove the ink cartridge (ink bag) and replace with a new one. Invert the new ink cartridge (ink bag) as instructed to agitate ink and then insert it into the ink slot. (This message appears when Remain Ink is set to [On])  "Replacing with a new ink" P. 160
[****] No Cart		Ink cartridge (ink bag) is not installed (Printer stops operation) Insert the ink cartridge (ink bag) into the ink slot.
No Cart.		An ink cartridge (ink bag) is not installed (in the example on the left, slot 1 and slot 2) Insert an ink cartridge (ink bag) into the ink slot. (This message appears when Remain Ink is set to [On])
[****] Discharged		Ink is not filled. Perform initial ink charging.  "Initial ink charging after flushing ink out of the printer" P. 222
Full WasteInkTank		The waste ink tank is full. (Stops operation) Immediately empty the tank.  "Emptying waste ink tank" P. 167
[****] S/C ReadErr		Failed to read the smartchip card. Insert the smartchip card again.
[****] S/C Col.Err		Ink cartridges (ink bags) are inserted in wrong slots. Insert them into the correct ink slots.
[****] S/C Ink Err		The ink cartridges (ink bags) cannot be used for this printer. Contact your local MUTOH dealer.
[****] S/C CodeErr		Inserted ink cartridge (ink bag) is not a proper one. Contact your local MUTOH dealer.
[****] Broken Chip		The smartchip card has been broken. Insert a new ink cartridge (ink bag).

Before Use

Basic Operations

Various Settings

Maintenance

When problems occur

Appendix

Messages and Error Messages

Troubleshooting

Display	Description
[****] Ink Low PG : Low W : 1625mm	The ink became low. (The printer continues operations) Prepare a new ink cartridge (ink bag) for replacement. (This message appears when Remain Ink is set to [Off])
Ink Low PG : Low W : 1625mm ■■■■■■■■	The ink becomes low. (In this example, slot 3 and slot 4 are low). (The printer continues operations) Prepare a new ink cartridge (ink bag) for replacement. (This message appears when Remain Ink is set to [Off])
Agitate W Ink ■■■■■■■■ CAUTION ■■■■■■ Agitate W Ink	The scheduled time has passed since the last ink agitation. Agitate the ink in the White (W) ink bag. ☞ "Agitating ink" P. 145
Agitate KMCY Ink ■■■■■■■■ CAUTION ■■■■■■ Agitate KMCY Ink	The scheduled time has passed since the last ink agitation. Agitate the ink in the Black (K), Magenta (M), Cyan (C) and Yellow (Y) ink bag. ☞ "Agitating ink" P. 145
Agitate KMCYW Ink ■■■■■■■■ CAUTION ■■■■■■ Agitate KMCYW Ink	The scheduled time has passed since the last ink agitation. Agitate the ink in the Agitate Black (K), Magenta (M), Cyan (C), Yellow (Y) and White (Wh) ink bag. ☞ "Agitating ink" P. 145
Agitate ALL Ink ■■■■■■■■ CAUTION ■■■■■■ Agitate ALL Ink	The scheduled time has passed since the last ink agitation. Agitate the ink in the Black (K), Magenta (M), Cyan (C) and Yellow (Y) ink bag. ☞ "Agitating ink" P. 145
Ink-agitate after printing.	The scheduled time has passed since the last ink agitation. Once printing is finished, follow the instruction on the control panel to agitate ink. ☞ "Agitating ink" P. 145

Important !!

Do not remove cartridges while printing.

Before Use

Basic Operations

Various Settings

Maintenance

When problems occur

Appendix

Messages and Error Messages

Troubleshooting

Display	Description
[****] Change Plug	The high-capacity ink pack adapter was used for a certain number of times. Replace with a new plug in the adapter.
Cannot Operate Outside Print Area	The printer is unable to print because there is not enough printable width on the media. Adjust printable width by changing CR origin and side margin (left and right side margin) settings. ☞ "Media Width" P. 111 , "Origin" P. 112 , "Side Margin" P. 111 Printable width needed varies depending on the types of test print. Adjust the above settings to secure enough width. ☞ "Print quality calibration ("Adjust Print")" P. 72 (at least 550 mm) ☞ "Media feed adjustment" P. 78 (at least 400 mm) ☞ "Print head calibration ("Adjust Head")" P. 68 (at least 550 mm) ☞ "Print" P. 131 , "Simple Print" P. 131 (at least 400 mm)
Cannot Operate Media Initial - Off	The printer is unable to display the "Roll Length Manage" menu because Media Initial is set to "Off". ☞ "Media Initial" P. 111 Set Media Initial to "Top&Width" or "Width" and then select "Menu 6 Roll Length Manage". ☞ "Roll Length Manage menu" P. 131
Cannot Operate No Media	The media is not loaded. Load the media. ☞ "Loading a roll media into the printer" P. 49
Cannot Operate Roll Length - Off	The printer is unable to print because the "Roll Length" setting is set to "Off". ☞ "Roll Length" P. 132 Specify the "Roll Length" settings and then select Print or Simple Print. ☞ "Print" P. 131 , "Simple Print" P. 131
Cannot Operate Output Mode - Take Up	The printer is unable to scan because Output Mode is set to "Take Up". ☞ "Output Mode" P. 111 Switch Output Mode to "Off" and then select the Scan menu. ☞ "Scan" P. 132
Drop Sensor Failed Auto NozzleCheck Off	The drop sensor is broken. Printing is still possible, but you cannot use the automatic nozzle check function. Please contact your local MUTOH dealer.

Before Use

Basic Operations

Various Settings



Maintenance

When problems occur

Appendix



Messages and Error Messages

Troubleshooting

Display	Description
Auto Nozzle Check Nozzle Clog Present	The printer run an auto cleaning cycle to recover blocked nozzles that an auto nozzle check detected, but the nozzles are still clogged. Manually run a nozzle check and cleaning cycles.  "Nozzle check and cleaning" P. 61
Ink Not Expired? OK -> Enter	Check the "Use Before" date on the cartridge (ink bag) label. Once you have finished checking the expiration date or replacing the ink cartridge (ink bag), tap  Enter key.
[****] Ink Expired	This message appears when the ink cartridge (ink bag) has expired. Replace with a non-expired one.

 **Note**

- "****" in the message "Change Head Gap ****" represents the head height (High, Middle, or Low).
- [****] in the error message indicates the target ink cartridge.
- If "Ink End" and "No Cartridge" errors occurred at the same time, "No Cartridge" will be displayed in priority to other two errors.

Display	Description
Temperature too low	<ul style="list-style-type: none">• Printer's temperature is too low. Adjust room temperature. Wait until the warning message is no longer displayed.  "Specifications" P. 253
Temperature too high	<ul style="list-style-type: none">• Printer's temperature is too high. Adjust room temperature. Wait until the warning message is no longer displayed.  "Specifications" P. 253

Before Use

Basic Operations

Various Settings

Maintenance

When problems occur

Appendix

Messages and Error Messages

Troubleshooting

Smartchip recovery

When the following message is prompted on the control panel, a smartchip error such as broken chip may have occurred in the smartchip card.

Check that the correct smartchip card is inserted and perform smartchip recovery.

This will allow you to continue to print.

To perform smartchip recovery, do one of the followings according to the message appeared.

Display	Description
[****] S/C Recog. E	The smartchip card that needs smartchip recovery may have been installed. Remove the smartchip card and insert it again. If the printer is still unable to read it, insert a new smartchip card. <ul style="list-style-type: none">If a message [[**] Check Color OK ->Enter] appears after the smartchip card is reinserted, follow the message [[**] Check Color OK ->Enter] to operate.
[**] Check Color OK -> Enter	The smartchip card that needs smartchip recovery may have been installed. Check that the ink color of the smartchip card inserted is correct. <ul style="list-style-type: none">In case of wrong color insertion, insert a correct smartchip card.If color is correct, tap  [Enter] key. The printer will perform smartchip recovery and will continue to print.

Note

- [**] in the error message indicates the target ink slot.
- During smartchip recovery execution, the ink cartridge being recovered blinks in the ink status menu.

 ["Ink" P. 128](#)

Before Use

Basic Operations

Various Settings

Maintenance

When problems occur

Appendix

Messages and Error Messages

Troubleshooting

Error requiring restart

An error requiring restart is displayed if a fatal operational failure such as the following occurs.

- When an error that prevents the printer from driving occurred.
- When the electrical circuit (PCB, motor, sensor, etc.) of the printer is broken.
- When a failure in the printer control program occurred.

If this error occurs, the printer will stop operation after

1. the power of drive source was automatically shut down.
2. all the LED on the printer control panel blink, and the buzzer beeps repeatedly.
3. the error message is displayed on the printer control panel and MUTOH Status Monitor.

Pressing any key on the control panel will stop the beeps. For this kind of error, operation will return to normal after removing the cause of the error and restarting the printer. If the same error occurs again, please contact your local MUTOH dealer. Be sure to tell us the code number of the error message when you contact us.

Message	Solutions
Emergency Mode : E***	A trouble that the error cannot be released has occurred. 1. Check that the part you replaced has been installed correctly. 2. Press Power button to turn the printer off. Wait for a while and press Power button again to restart the printer.
Emergency Mode : AC	The printer instantaneously shut down while starting. 1. Press Power button to turn the printer off. Wait for a while and press Power button again to restart the printer.
Emergency Mode : CPU	CPU error has occurred. 1. Press Power button to turn the printer off. Wait for a while and press Power button again to restart the printer.

Note

“***” in the error message is the error code that identifies what type of error occurred.

Before Use

Basic Operations

Various Settings

Maintenance

When problems occur

Appendix

Messages and Error Messages

Troubleshooting



Troubleshooting

This section describes printer troubles that an error message is not prompted, and possible cause and solutions.

Note

- The printer status and error information can be checked from the Printer Status tab > Status Information on MSM.
If your printer is not operating correctly, check this Status Information first.
- Make sure to use the latest version of MSM.
To check the latest available version, go to Help > Version > Check for updates on MSM.
If old version is installed in your computer, download the latest version from MUTOH Club.
 [MUTOH Status Monitor Operation Manual](#)

Installation and initial setup-related trouble

Description	Possible cause and Remedy
Cannot perform the initial inkcharging.	Check that the front cover and the maintenance cover are closed.
	Check that the pressure rollers are down.
	Make sure ink cartridges are all the way seated in the ink slots.  "Replacing with a new ink" P. 160
Ink does not come out after ink charging.	Check that the ink cartridge (ink bag) is not too cold. <ul style="list-style-type: none">• Rest the ink cartridge (ink bag) at room temperature for at least three hours, and perform cleaning several times.  "Head cleaning" P. 185
	Is the power turned OFF during ink charging? <ul style="list-style-type: none">• Turn the power ON and perform an initial ink charging again.

Before Use

Basic Operations

Various Settings

Maintenance

When problems occur

Appendix

Messages and Error Messages

Troubleshooting

Description	Possible cause and Remedy
Nozzle clogging occurs after initial ink charging.	Did you perform head cleaning? <ul style="list-style-type: none">• Perform cleaning, then, check the print result. ☞ “Head cleaning” P. 185• If there is no improvement in the print result even after performing cleaning, leave the printer unused for an hour or more. Then perform cleaning or “Little Charge” again and check the print result.• If the problem still persists, contact your local Mutoh dealer.
MSM or RIP cannot access to the printer.	Check that the Ethernet cable is connected securely to the Ethernet port.
	Check that the network settings are configured correctly.
	Check that the printer’s network settings match with the computer’s settings. ☞ “Connecting to a computer” P. 33 , “Init. Settings” P. 118

Before Use

Basic Operations

Various Settings

Maintenance



When problems occur

Appendix

Messages and Error Messages

Troubleshooting

Boot-up trouble

Symptom	Possible cause and Remedy
Printer does not work at all after powered on or even after media is loaded.	Check that the power cord is plugged into the wall outlet.
	Does the AC power supply provide the specified voltage? <ul style="list-style-type: none">• Connect the cable to another outlet.
	Check that the front cover and the maintenance covers are closed.
	Check that the pressure rollers are down.
	Check that the media is loaded into the printer correctly.  “Loading a roll media into the printer” P. 49
	Check that the ink cartridges (ink bags) are inserted into the ink slots.
	Do you use the printer within recommended environmental requirements? <ul style="list-style-type: none">• Make sure to use the printer within the specification range.  “Check before installation” of the “Startup Guide”
Is there any error message displayed on MSM? <ul style="list-style-type: none">• Go to the Printer Status tab in MSM and check that if any error message is displayed in the Status Information.	

Before Use

Basic Operations

Various Settings

Maintenance





When problems occur

Appendix

Messages and Error Messages

Troubleshooting

Media-related trouble

Symptom	Possible cause and Remedy
The media slips, is torn /crumpled during initialization.	Check that the media is loaded into the printer correctly.  "Loading a roll media into the printer" P. 49
	Are there any foreign materials such as torn paper attached to the pressure rollers? <ul style="list-style-type: none">• Clean the pressure rollers.  "Cleaning inside the printer" P. 193
	Do you use the printer within recommended environmental requirements? <ul style="list-style-type: none">• Make sure to use the printer within the specification range.  "Check before installation" of the "Startup Guide"
	Are any curls or warps present on your media? <ul style="list-style-type: none">• Place the edge holder on both edges of the media.• Check that you select the appropriate vacuum fan setting.  "5. After loading the media" P. 59,"Vacuum Fan" P. 110
	Are you using creased, damaged, torn or curled media? <ul style="list-style-type: none">• Replace the media.
	Is holddown pressure adequate for the roll media? <ul style="list-style-type: none">• Use the slide lock lever on the individual pressure rollers to reduce or cancel the pressure.  "Canceling or reducing pressure rollers individually" P. 94

Note

If the media is jammed or torn, remove it according to ["The media is jammed" P. 249](#)

Before Use

Basic Operations

Various Settings





Maintenance

When problems occur

Appendix

Messages and Error Messages

Troubleshooting

Symptom	Possible cause and Remedy
The printer does not detect the media.	Check that the media is loaded into the printer correctly.  "Loading a roll media into the printer" P. 49
	Is the media loaded at an angle? • Load the media straight.  "Loading a roll media into the printer" P. 49
	Do you use the printer within recommended environmental requirements? • Make sure to use the printer within the specification range.  "Check before installation" of the "Startup Guide"
	Did you load the media which has been printed before? • Use a new media.
Media jams frequently occur.	Do you use the printer within recommended environmental requirements? • Make sure to use the printer within the specification range.  "Check before installation" of the "Startup Guide"
	Are any curls or warps present on your media? • Set the edge holder at both edges of the media. • Check that you select the appropriate vacuum fan setting.  "5. After loading the media" P. 59, "Vacuum Fan" P. 110
	Are you using creased, damaged, torn or curled media? • Replace the media.

 **Note**

If the media is jammed or torn, remove it according to ["The media is jammed" P. 249](#)

Symptom	Possible cause and Remedy
The media skews during printing.	Check that the media is loaded into the printer correctly.  "Loading a roll media into the printer" P. 49

Before Use

Basic Operations

Various Settings

Maintenance





When problems occur

Appendix

Messages and Error Messages

Troubleshooting

Printing-related trouble

Symptom	Possible cause and Remedy
The printer does not print.	<p>Check that the Ethernet cable is connected securely to the Ethernet port.  "Connecting to a computer" P. 33</p> <p>Is there any error message displayed on MSM?</p> <ul style="list-style-type: none">Go to the Printer Status tab in MSM and check that if any error message is displayed in the Status Information.
The carriage pauses at either side of the printer while printing.	<p>Does your computer meets the following requirements?</p> <ul style="list-style-type: none">OS: Windows 11, Windows 10CPU: Intel (R) Core (TM) i5 or moreMemory: No less than 8G byteNetwork: Use a network port that supports Gigabit Ethernet, and an Ethernet cable that supports Category 6 Gigabit Ethernet or later. <div data-bbox="1279 619 2123 842"><p> Note</p><ul style="list-style-type: none">The OS support period of MUTOH software follows the Microsoft support lifecycle policies.When using RIP software, please also see the system requirements of your RIP software.</div> <p>Do you use a Gigabit Ethernet cable?</p> <ul style="list-style-type: none">To connect your printer to your computer, use a Gigabit Ethernet cable Category 6 or later.  "Connecting to a computer" P. 33 <p>Is MPS enabled?</p> <ul style="list-style-type: none">Check the status of MPS.  "MPS" P. 102When set to "On": Check that your computer (specification, CPU load), Ethernet cable (specification, connectivity) and network environment meet the requirements.When set to "Off": In MSM, the checkbox "MUTOH Print Server (MPS)" is unchecked or "MPS Optimization" is set to "Disable". Try enabling MPS in MSM. <div data-bbox="1279 1289 2123 1396"><p> Note</p><p>MPS settings can be changed in MSM.</p></div>

Before Use

Basic Operations

Various Settings







Maintenance

When problems occur

Appendix

Messages and Error Messages

Troubleshooting

Symptom	Possible cause and Remedy
Smears or missing area partially appears on the prints.	Are any curls or warps present on your media? <ul style="list-style-type: none">Place the edge holder on both edges of the media.Check that you select the appropriate vacuum fan setting.  "5. After loading the media" P. 59, "Vacuum Fan" P. 110
	Does the media contain moisture or are you using the creased or wrinkled media? <ul style="list-style-type: none">Replace it with the new media.
	Is there any dirt around the print head? <ul style="list-style-type: none">Clean the circumference of the print head.  "2. Cleaning of the parts around the print head" P. 176
The printing position is incorrect (some parts of the media cannot be printed on).	Is an error message "Temperature too low" or "Temperature too high" displayed on the control panel? <ul style="list-style-type: none">If the product is used in an environment that does not meet 'Environmental Requirements', the print head may not fire ink properly. In such cases, adjust the room temperature. Once you confirm the message is no longer displayed, perform a head cleaning.
	Check that the media is loaded into the printer correctly.  "Loading a roll media into the printer" P. 49
Printing is blurred.	Did you set up the origin? <ul style="list-style-type: none">Cancel or reset the settings of the origin.  "Origin" P. 112
	Is the media printed on the printing surface? <ul style="list-style-type: none">Check the printing surface of the media and set it correctly.
	Did you perform Print quality adjustment? <ul style="list-style-type: none">Perform Print quality adjustment.  "Print quality calibration ("Adjust Print")" P. 72
	Did you perform Media feed adjustment? <ul style="list-style-type: none">Perform Media feed adjustment.  "Media feed adjustment" P. 78

Before Use

Basic Operations

Various Settings

Maintenance

When problems occur

Appendix

Messages and Error Messages

Troubleshooting

Symptom	Possible cause and Remedy
White or black lines appear on printed media.	Check that the media is loaded into the printer correctly. ☞ “Loading a roll media into the printer” P. 49
	Does the media contain moisture or are you using the creased or wrinkled media? • Replace it with the new media.
	Are nozzles in good condition? • Perform a nozzle check. • Then if nozzle clogs, conduct cleaning. ☞ “Nozzle check and cleaning” P. 61
	Did you perform print quality adjustment? • Perform a print quality adjustment. ☞ “Print quality calibration (“Adjust Print”)” P. 72
Printing lines are not straight/ are duplicated or patchy.	Did you perform media feed adjustment? • Perform a media feed adjustment. ☞ “Media feed adjustment” P. 78
	Are nozzles in good condition? • Perform a nozzle check. • Then if nozzle clogs, conduct cleaning. ☞ “Nozzle check and cleaning” P. 61
	Did you perform print quality adjustment? • Perform a print quality adjustment. ☞ “Print quality calibration (“Adjust Print”)” P. 72
	Did you perform media feed adjustment? • Perform a media feed adjustment. ☞ “Media feed adjustment” P. 78
	Is ink cartridge (ink bag) within the validity period? • Use a non-expired ink cartridge (ink bag).

Before Use

Basic Operations

Various Settings





Maintenance

When problems occur

Appendix

Messages and Error Messages

Troubleshooting

Symptom	Possible cause and Remedy
Printed color is not accurate.	Are nozzles in good condition? <ul style="list-style-type: none">• Perform a nozzle check.• Then if nozzle clogs, conduct cleaning.  "Nozzle check and cleaning" P. 61
	Did you install ink cartridges (ink bags) and smartchip cards in the printer in correct color combination? <ul style="list-style-type: none">• Check that the ink color written on smartchip card matches the ink color of ink cartridge (ink bag).• If it does not match, perform "Longstore" to clean the print head and then perform initial ink charging.
	When "Agitate XX Ink" message appears on the control panel, agitate ink in the ink cartridge (ink bag)..  "Agitating ink" P. 145
	Is ink cartridge (ink bag) within the validity period? <ul style="list-style-type: none">• Use a non-expired ink cartridge (ink bag).
	Do you set the Color Maintenance menu to [Off]? <ul style="list-style-type: none">• Set the Color Maintenance menu to [Normal] or [Little].  "Color Maintenance" P. 116
	Do you set the Print Stop menu to [Off]? <ul style="list-style-type: none">• Printing without ink agitation could cause mottled print as the density of the ink in the cartridge (or ink bag) gets reduced.• Set the Print Stop menu to [On]. Then flush ink out of the printer and perform initial ink charging using new ink cartridges (or ink bags).  "Print Stop setting" P. 137 , "2. Flush ink out of printer" P. 216 , "Initial ink charging after flushing ink out of the printer" P. 222
Is an error message "Temperature too low" or "Temperature too high" displayed on the control panel? <ul style="list-style-type: none">• If the product is used in an environment that does not meet 'Environmental Requirements', the print head may not fire ink properly. In such cases, adjust the room temperature. Once you confirm the message is no longer displayed, perform a head cleaning.	

Before Use	
Basic Operations	
Various Settings	
Maintenance	
When problems occur	<p>Messages and Error Messages</p> <p>Troubleshooting</p>
Appendix	

Symptom	Possible cause and Remedy
Nozzle clogging remains after head cleaning.	<p>Is there any ink stains or deposits on the cleaning wiper or circumference of the print head?</p> <ul style="list-style-type: none"> • Clean the cleaning wiper and circumference of the print head. <ul style="list-style-type: none"> ☞ "2. Cleaning of the parts around the print head" P. 176, "3. Cleaning of the cleaning wiper and the parts around the capping unit" P. 179
	<p>Did you select an appropriate cleaning option?</p> <ul style="list-style-type: none"> • Head Select: Select "ALL" or the print head which nozzle Clogging occurs. <ul style="list-style-type: none"> ☞ "Perform a head cleaning" P. 65 • Cleaning Mode: If nozzle clogging still persists after attempting Normal Cleaning or Long Cleaning two or three times, perform "Little Charge". <ul style="list-style-type: none"> ☞ "Perform a head cleaning" P. 65 • Select Nozzle: If Little Charge does not recover the nozzles, go to Select Nozzle and select the nozzles that are firing properly. <ul style="list-style-type: none"> ☞ "Select Nozzle" P. 119
	<p>Is it time to replace the cleaning wiper or the pad for the flushing box?</p> <ul style="list-style-type: none"> • Check the conditions of cleaning wiper and flushing box pad and replace them if required. <ul style="list-style-type: none"> ☞ "Replacing the flushing box pad" P. 197, "Replacing the cleaning wiper" P. 201

Before Use

Basic Operations

Various Settings

Maintenance

When problems occur

Appendix

Messages and Error Messages

Troubleshooting

The media is jammed

When the media is jammed in the printer, follow these steps to remove it.

- 1 Long press the Power button.
 - The printer begins powering off.
 - When the message [Power Off] appears on the panel, release the Power button.

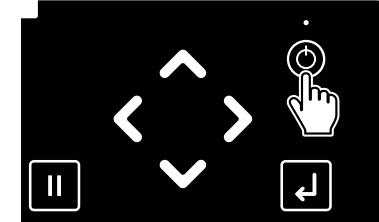

- 2 Open the front cover.

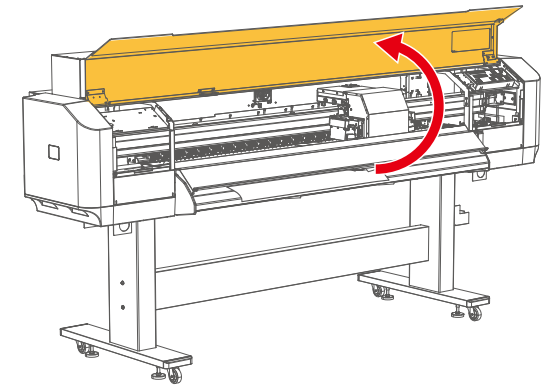

- 3 Move the carriage on the media to the right side.

Important !!

When the head height is set to Low or Middle, change it to High and then move the carriage. After moving, change the head height back to Low or Middle.

 ["Printhead Height" P. 91](#)

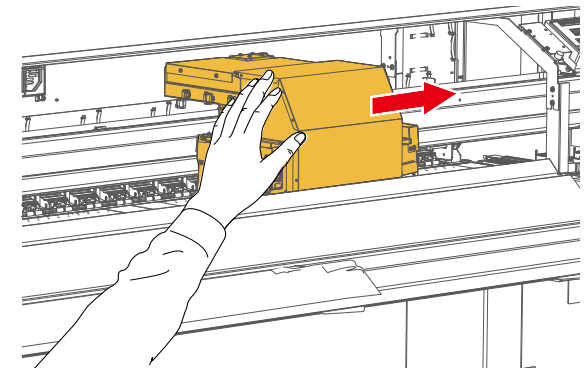

Before Use

Basic Operations

Various Settings

Maintenance

When problems occur

Appendix

Messages and Error Messages

Troubleshooting

- 4 Slide the edge holder to remove it from the media.

Important !!

If any deformation is found on the edge holder, stop using it and contact your local MUTOH dealer.

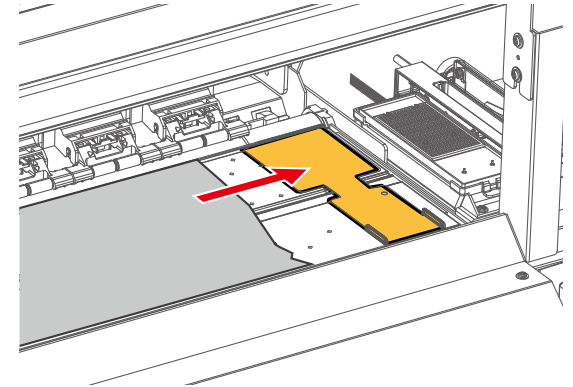

- 5 From the front side of the printer, fully pull the media feed lever towards you to release the pressure rollers.

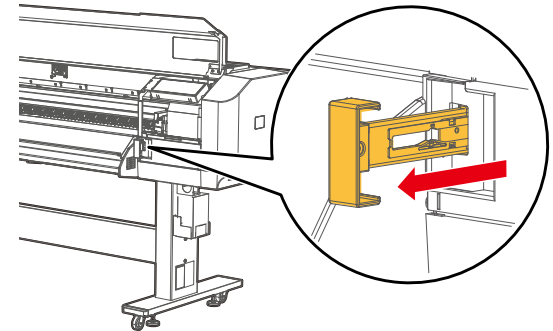

- 6 Pull the media towards you and use a personal cutter to cut the torn part of the media along the groove.

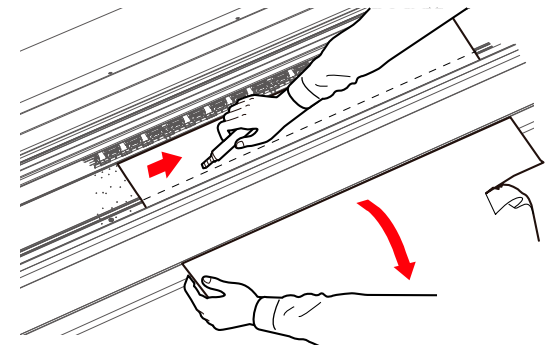

Before Use

Basic Operations

Various Settings

Maintenance

When problems occur

Appendix

Messages and Error Messages

Troubleshooting

- 7 Turn the flange on the media holder to rewind the media onto the roll.

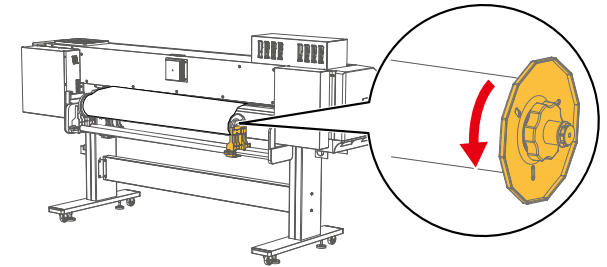

- 8 If paper dust or pieces of paper remain inside the printer, remove them.

- 9 Turn the printer ON.

- 10 Load a roll media to print a nozzle check pattern.
👉 ["Loading a roll media into the printer" P. 49](#)

- 11 Tap  key.
👉 ["Direct keys" P. 29](#)

- 12 [Start Printing? Nozzle Check F] appears, tap  [Enter] key.
 - The printer will print the nozzle check pattern F.

- 13 Check the nozzle check print to see all nozzles are clear.
 - If you find missing or thin lines on the print, go to ["Perform a head cleaning" P. 65](#).
 - If all lines are clearly printed, you can start printing.

Appendix

Specifications 253

Optional accessories / Consumable supplies 256

Revision history 257

Before Use

Basic Operations

Various Settings

Maintenance

When problems occur

Appendix

Specifications

Optional accessories /
Consumable supplies

Revision history

Specifications

Name	Description	
Model name	XPJ-1682UR	
Printing method	On demand piezo method	
Driving method	Firmware servo/ DC motor drive	
Media feed method	Multipoint pressurizing Grid roller system	
Media hold-down system	Pressure roller down system by manual lever	
Ink curing system	UV-LED lamp	
Media size	Media outer diameter	Φ200 mm or less
	Media core diameter	2 inches or 3 inches
	Weight	30 kg or less
	Width	500 mm to 1,625 mm
	Recommended media thickness	1.0 mm or less
Maximum printable width	1,615 mm	
Maximum printable length	200m	
Head height adjustment	Three adjustment options: Low, Middle, and High	
Interface	Gb-Ethernet (1000BASE-T)	
Waste ink tank	2,000 ml tank is attached to the printer. Empty the tank when needed.	
Ink	Color	6 colors (Black, Cyan, Magenta, Yellow, White, Varnish)
		4 colors (Black, Cyan, Magenta, Yellow)
	Type	US 61
capacity	<ul style="list-style-type: none">US 61:<ul style="list-style-type: none">220 ml (ink cartridge), 800 ml (ink bag)cleaning cartridges<ul style="list-style-type: none">220 ml	

Before Use

Basic Operations

Various Settings

Maintenance

When problems occur

Appendix

Specifications

Optional accessories /
Consumable supplies

Revision history

Name	Description
Environmental requirements	Printer Operation Environment Temperature 20 to 32 °C Humidity 40 to 60%, No condensation
	Recommended Printing Environment Temperature 22 to 30 °C Humidity 40 to 60%, No condensation
	Change rate Temperature: No more than 2 °C per 1 hour Humidity: No more than 5% per 1 hour
	Printer Storage Environment Storage without ink filled: up to 6 months Temperature -20 to 60 °C Humidity 20 to 80%, No condensation Storage with ink filled: Up to 1 month*1 Temperature 5 to 30 °C Humidity 20 to 80%, No condensation *1 Printer must be put into sleep mode. Make sure to check ink level.
Ink Storage Environment	<ul style="list-style-type: none">• US61 Black/Cyan/Magenta/Yellow/White/Varnish Temperature : 5 to 30 °C (Store in a cool, dark place).• Cleaning cartridge Temperature : -20 to 40 °C (Store at 40 °C: within 1 month) (Keep away from heat and flammable materials. Store in a cool, dark and well-ventilated place).
Power supply specifications	Voltage AC 100V to 240V ±10%
	Frequency 50/ 60 Hz ±1Hz
	Current 10.5 A or less (AC 100V to 120V) 5.0 A or less A (AC 200V to 240V)
Power consumption	Power off 20 W or below
	Ready-to-print 70 W or below
	Sleep Mode 21 W or below
	Operation 950 W or below

Before Use

Basic Operations

Various Settings

Maintenance

When problems occur

Appendix

Specifications

Optional accessories /
Consumable supplies

Revision history

Name	Description
Dimensions	Height 1,428 mm
	With high-capacity ink pack adapter installed 1,611 mm
	Width 2,770 mm
	Depth 895 mm
Weight	Main body 146 kg
	Stand 32 kg
	Take Up unit 8 kg (Optional unit)

Before Use

Basic Operations

Various Settings

Maintenance

When problems occur

Appendix

Specifications

Optional accessories /
Consumable supplies

Revision history

Optional accessories / Consumable supplies

For information about optional accessories and consumable supplies, please contact your local MUTOH dealer.

Before Use

Basic Operations

Various Settings

Maintenance

When problems occur

Appendix

Specifications

Optional accessories /
Consumable supplies

Revision history

Revision history

Date	Version	Manual	Supported Firmware
2024.07	00	XPJ1682URE-A-00	V.1.00
2024.09	01	XPJ1682URE-A-01	V.1.00
2024.10	02	XPJ1682URE-A-02	V.1.01
2025.01	03	XPJ1682URE-A-03	V.1.02
2025.03	04	XPJ1682URE-A-04	V.1.03
2025.08	05	XPJ1682URE-A-05	V.1.05
2026.03	06	XPJ1682URE-A-06	V.1.05 or later